

REV A - MKM - 5/10/19 - UPDATED FRAME ORIENTATION, HOLE LOCATIONS & ADDED LIFT RINGS
 REV B - JCG - 6/21/19 - ADDED SAFETY LATCH & ROTATED VIEWS TO SHOW LATCH

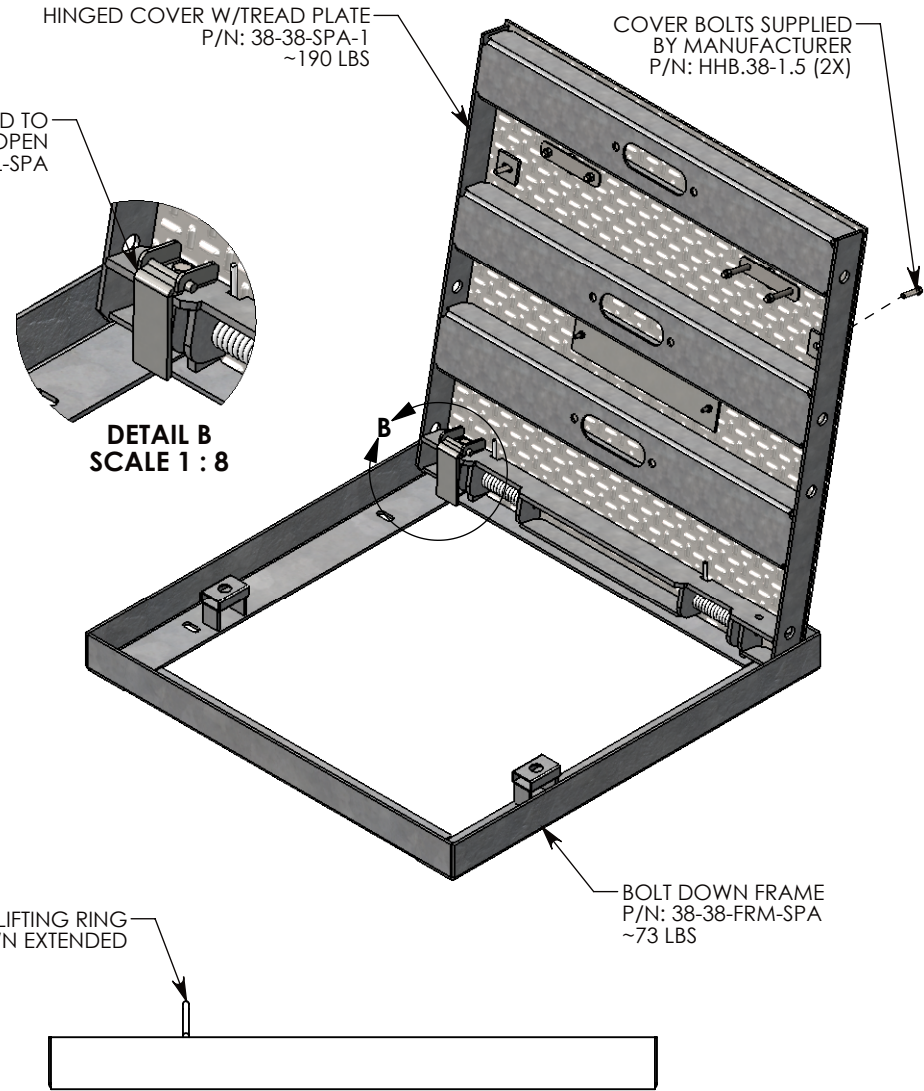
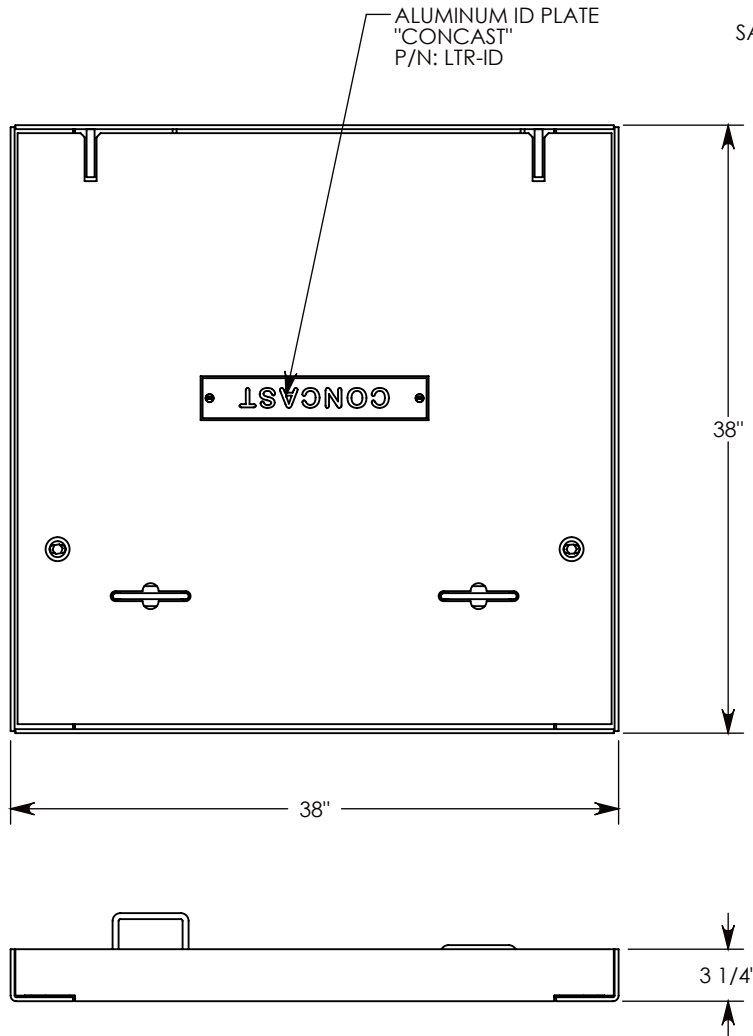

NOTE 1: FOR ADDED SECURITY, PENTA HEAD (P/N: PTA.38-1.5) OR SURELOCK BOLTS (P/N: SL.38-1.25) CAN BE ADDED

AASHTO H-20 RATED – 32,000 LB. SINGLE AXLE LOAD

DRAWN BY: MALACHI MLINAR	
CREATED DATE: 5/9/2019	REVISION LEVEL: C
SAVED DATE: 4/17/2020	SAVED BY: jgutting
WEIGHT: 264 LBS.	MATERIAL: GALV. WELDED STEEL

CONCAST
 1010 NORTH STAR DRIVE
 P.O. BOX 69
 ZUMBROTA, MN 55992-0069

DESCRIPTION: SG SPRING-ASSISTED COVER W/BOLT-DOWN		SHEET 1 OF 2
DIMENSIONS ARE IN INCHES TOLERANCES: FRACTIONAL: ± 1/8" ANGULAR: ± 2°	CONTACT INFORMATION: EMAIL: INFO@CONCASTINC.COM PHONE: (507) 732-4095 FAX: (507) 732-4094	
PART NUMBER: 38-38-SPA		