

FIBERCRETE®

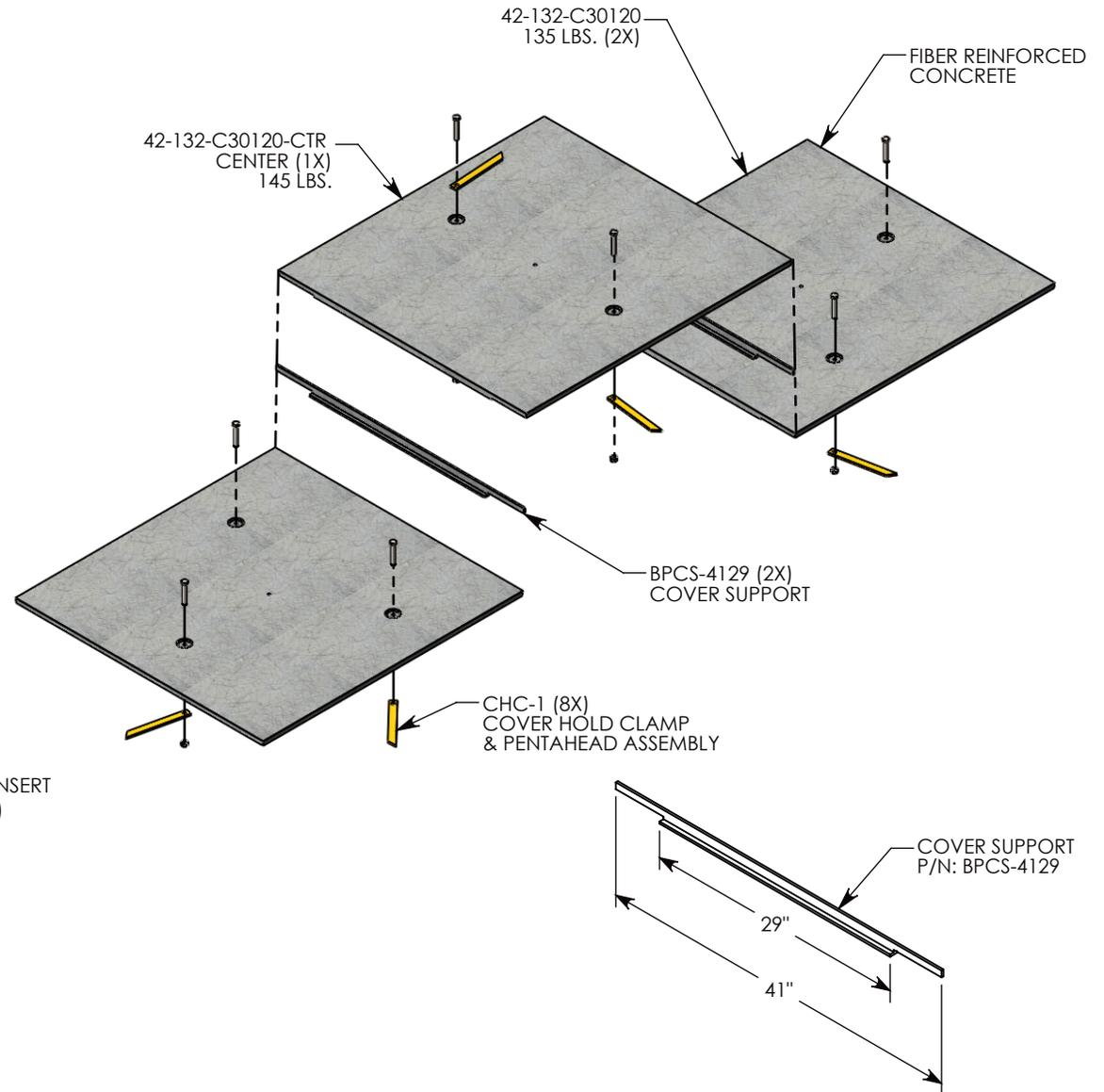
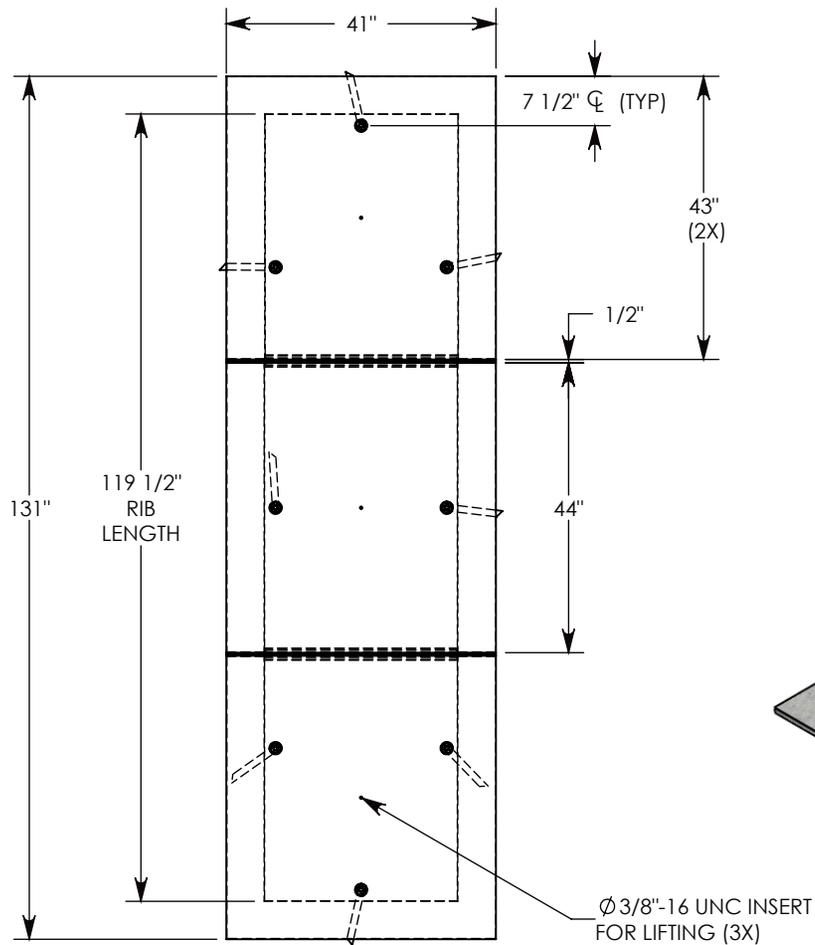

**DRAWN BY: ROBIN FLINT**

**DATE: 7/10/2012**

**REVISION LEVEL: 0**

**WEIGHT:**

**433 LBS. TOTAL**

**MATERIAL:**

**FIBERCRETE**

**CONCAST**  
 1010 NORTH STAR DRIVE  
 P.O. BOX 69  
 ZUMBROTA, MN 55992-0069

**DESCRIPTION:**

**FIBERCRETE BOX PAD COVERS**

DIMENSIONS ARE IN INCHES  
 TOLERANCES:  
 FRACTIONAL: ± 1/8"  
 ANGULAR: ± 2°

CONTACT INFORMATION:  
 EMAIL: INFO@CONCASTINC.COM  
 PHONE: (507) 732-4095  
 FAX: (507) 732-4094

SHEET 1 OF 1

**PART NUMBER:**

**42-132-C30120**