

COVER ASSEMBLES ONTO 24" INSIDE WIDTH
HEAVY TRAFFIC H-20 RATED CONCAST HT3 TRENCH

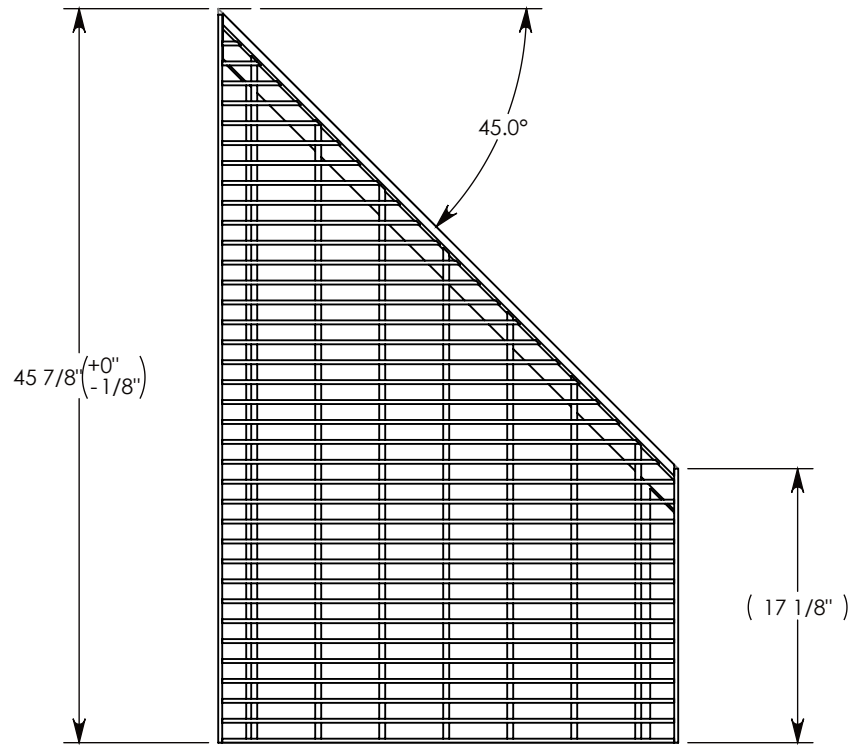

WELDED GALVANIZED STEEL GRATE

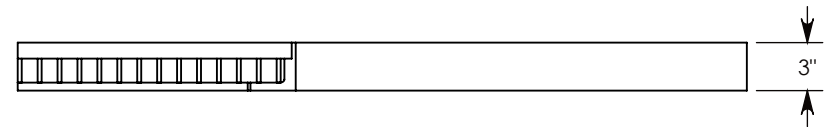
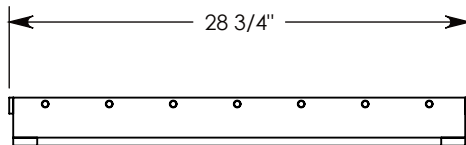
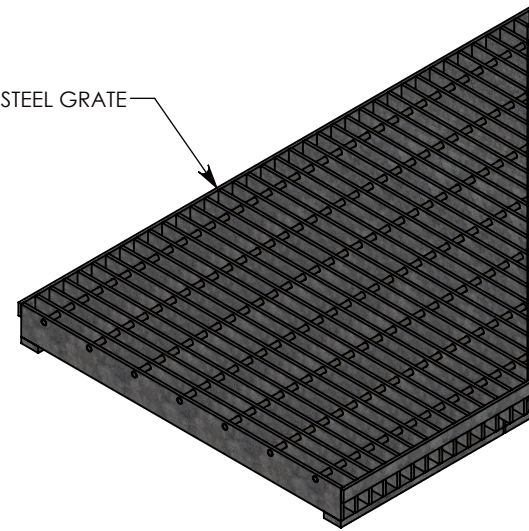

NOTE 1: FOR NON-STANDARD LENGTHS, THE PART NUMBER WILL CORRESPOND TO IT'S MEASURED LENGTH. IE: 8024HTSGV 45R 30"

AASHTO H-20 RATED – 32,000 LB. SINGLE AXLE LOAD

DRAWN BY: ROSS LAGER

DATE: 2/6/2019

REVISION LEVEL: 0

WEIGHT:

173 LBS.

MATERIAL:

GALVANIZED STEEL



1010 NORTH STAR DRIVE
P.O. BOX 69
ZUMBROTA, MN 55992-0069

DESCRIPTION:

VENTILATED STEEL COVER - 45 DEG. ANGLE

DIMENSIONS ARE IN INCHES
TOLERANCES:
FRACTIONAL: ± 1/8"
ANGULAR: ± 2°

CONTACT INFORMATION:
EMAIL: INFO@CONCASTINC.COM
PHONE: (507) 732-4095
FAX: (507) 732-4094

SHEET 1 OF 1

PART NUMBER:

8025HTSGV 45R