

FIBERCRETE[®]
TRENCH
SYSTEM

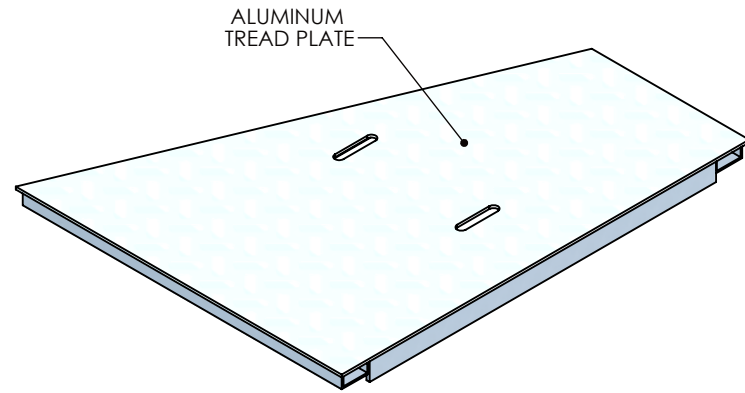

COVER ASSEMBLES ONTO 24" INSIDE WIDTH PEDESTRIAN RATED CONCAST PT CHANNEL

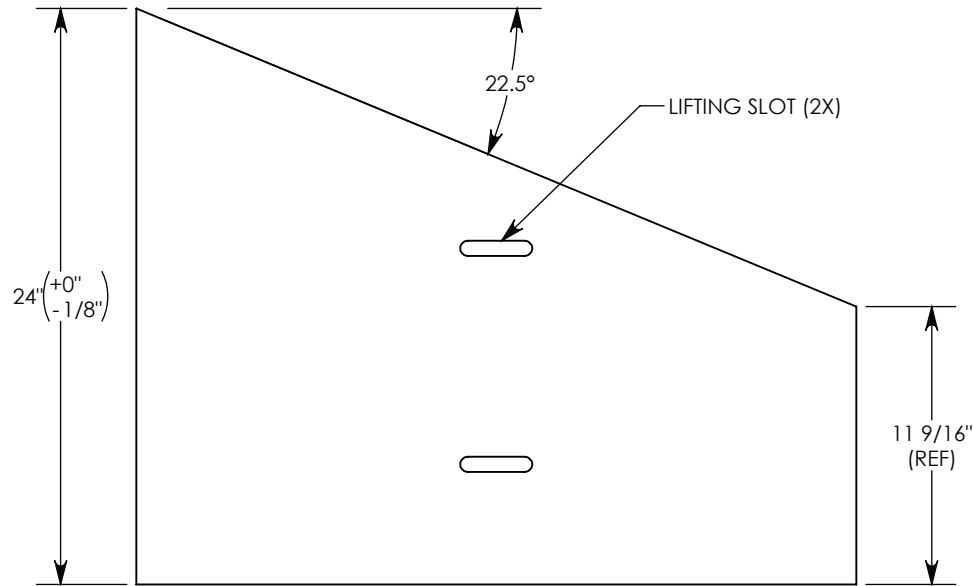
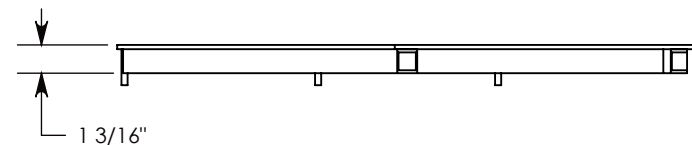
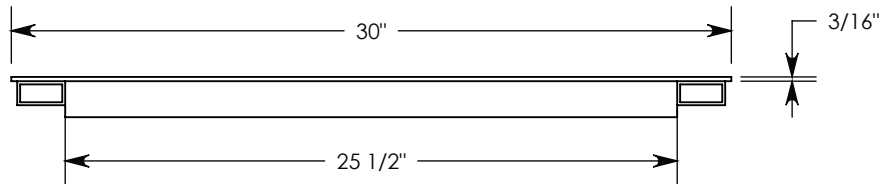

NOTE 1: FOR NON-STANDARD LENGTHS THE PART NUMBER WILL CORRESPOND TO IT'S MEASURED LENGTH. IE: 8025PTAT_22.5R 24"

PEDESTRIAN RATED - 200 LB. PER SQ. FOOT

DRAWN BY: ROBIN FLINT

DATE: 11/28/2015

REVISION LEVEL: 0

WEIGHT:

16 LBS.

MATERIAL:

WELDED ALUMINUM



DESCRIPTION:

ALUMINUM COVER - 22.5 DEGREE ANGLE

DIMENSIONS ARE IN INCHES

TOLERANCES:
 FRACTIONAL: ± 1/8"
 ANGULAR: ± 2°

CONTACT INFORMATION:

EMAIL: INFO@CONCASTINC.COM
 PHONE: (507) 732-4095
 FAX: (507) 732-4094

SHEET 1 OF 2

PART NUMBER:

8025PTAT 22.5R