

REMOVEABLE ALUM.  
COVER SUPPORT (2X)

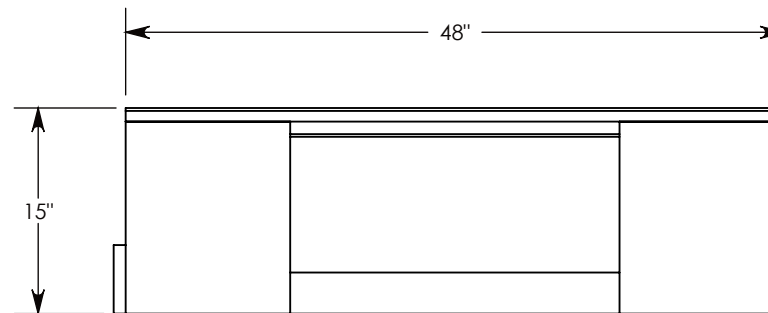
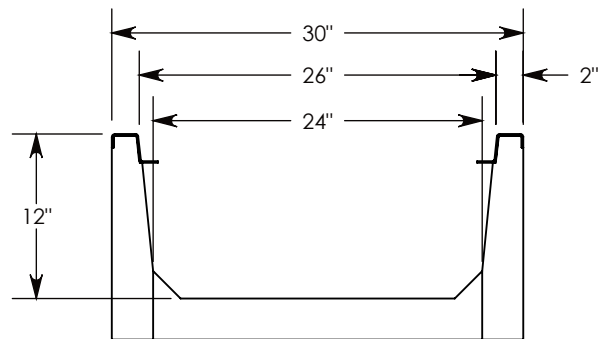
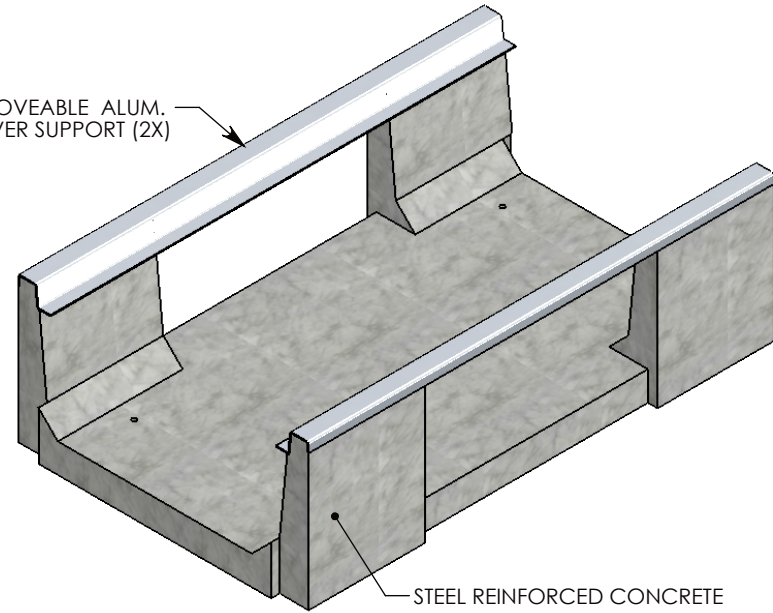

PEDESTRIAN RATED - 200 LB. PER SQ. FOOT

**DRAWN BY:** ROBIN FLINT

**CREATED DATE:** 3/11/2002 **REVISION LEVEL:** A

**SAVED DATE:** 9/9/2019 **SAVED BY:** scallahan

**WEIGHT:** 475 LBS. **MATERIAL:** CONCRETE

**CONCAST**  
1010 NORTH STAR DRIVE  
P.O. BOX 69  
ZUMBROTA, MN 55992-0069

**DESCRIPTION:**  
**PEDESTRIAN UNIVERSAL CHANNEL**

DIMENSIONS ARE IN INCHES  
TOLERANCES:  
FRACTIONAL: ± 1/8"  
ANGULAR: ± 2°

CONTACT INFORMATION:  
EMAIL: INFO@CONCASTINC.COM  
PHONE: (507) 732-4095  
FAX: (507) 732-4094

SHEET 1 OF 1

**PART NUMBER:**  
**8026PT (24X24)**