

**FIBERCRETE<sup>®</sup>**  
**TRENCH**  
**SYSTEM**

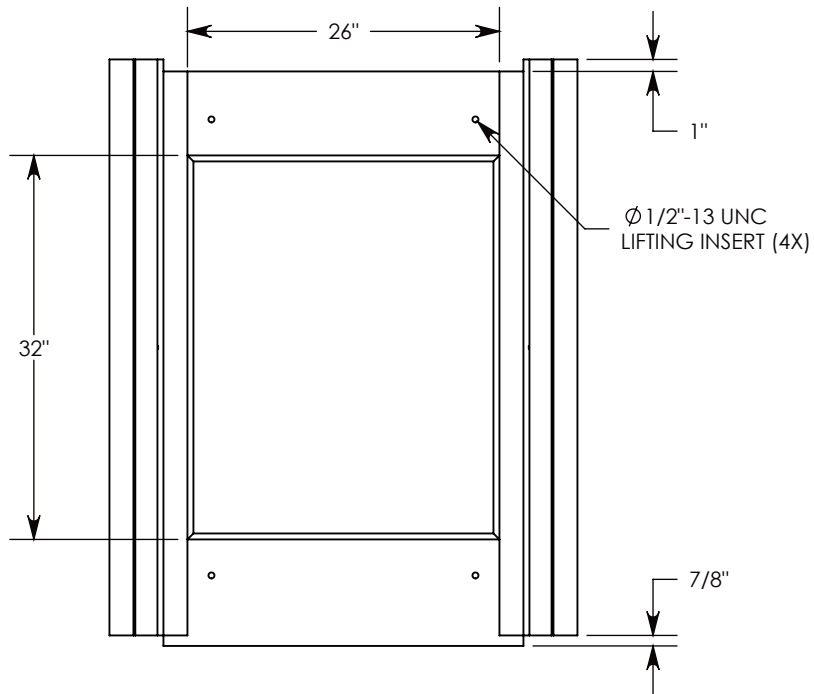

GALV. STEEL TOP RAIL (TYP.)

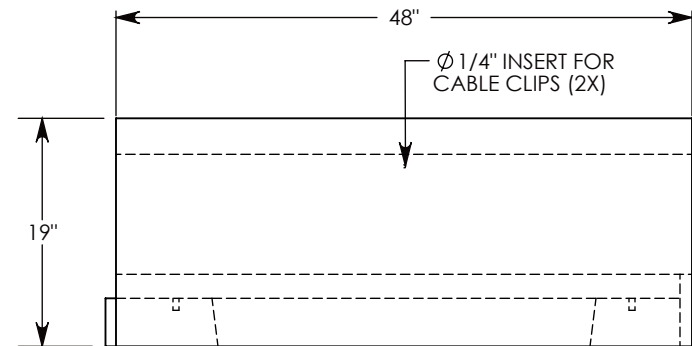
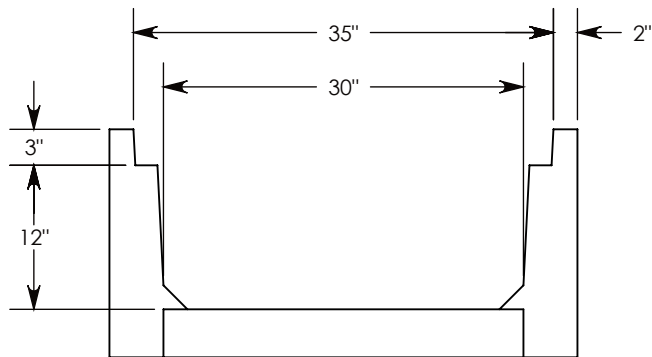
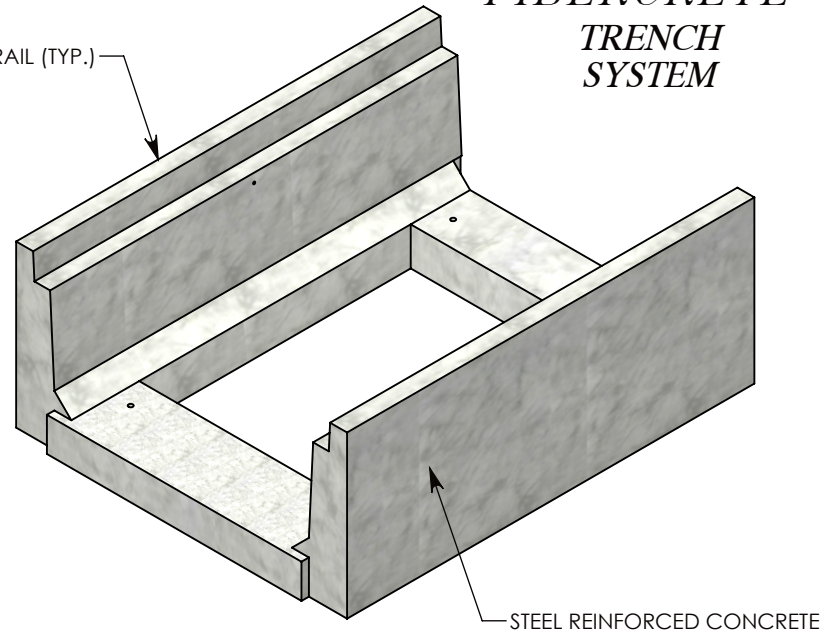

NOTE: FOR NON-STANDARD LENGTHS THE CHANNEL WILL BE SOLID BOTTOM AND DESIGNATED WITH ITS CORRESPONDING LENGTH MEASUREMENT. IE: 8030LT 32"

H-10 RATED - 16,000 LB. PER AXLE LOAD

**DRAWN BY: ROBIN LEWIS**

**DATE: 5/31/2016**

**REVISION LEVEL: 0**

**WEIGHT:**

**900 LBS.**

**MATERIAL:**

**NOTED**

**CONCAST**  
 1010 NORTH STAR DRIVE  
 P.O. BOX 69  
 ZUMBROTA, MN 55992-0069

**DESCRIPTION:**

**LIGHT TRAFFIC CHANNEL**

DIMENSIONS ARE IN INCHES  
 TOLERANCES:  
 FRACTIONAL: ± 1/8"  
 ANGULAR: ± 2°

CONTACT INFORMATION:  
 EMAIL: INFO@CONCASTINC.COM  
 PHONE: (507) 732-4095  
 FAX: (507) 732-4094

SHEET 1 OF 1

**PART NUMBER:**

**8030LT**