

**FIBERCRETE<sup>®</sup>**  
**TRENCH**  
**SYSTEM**

**REFERENCE ASSEMBLY**

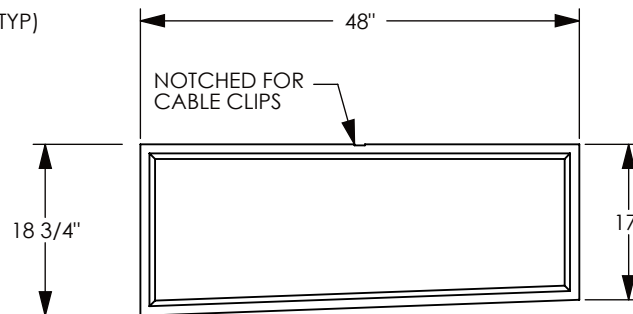

FIBER & STEEL  
 REINFORCED  
 CONCRETE

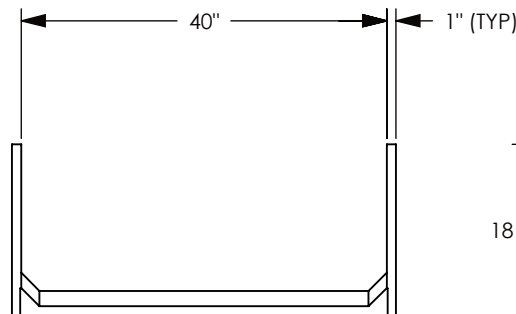
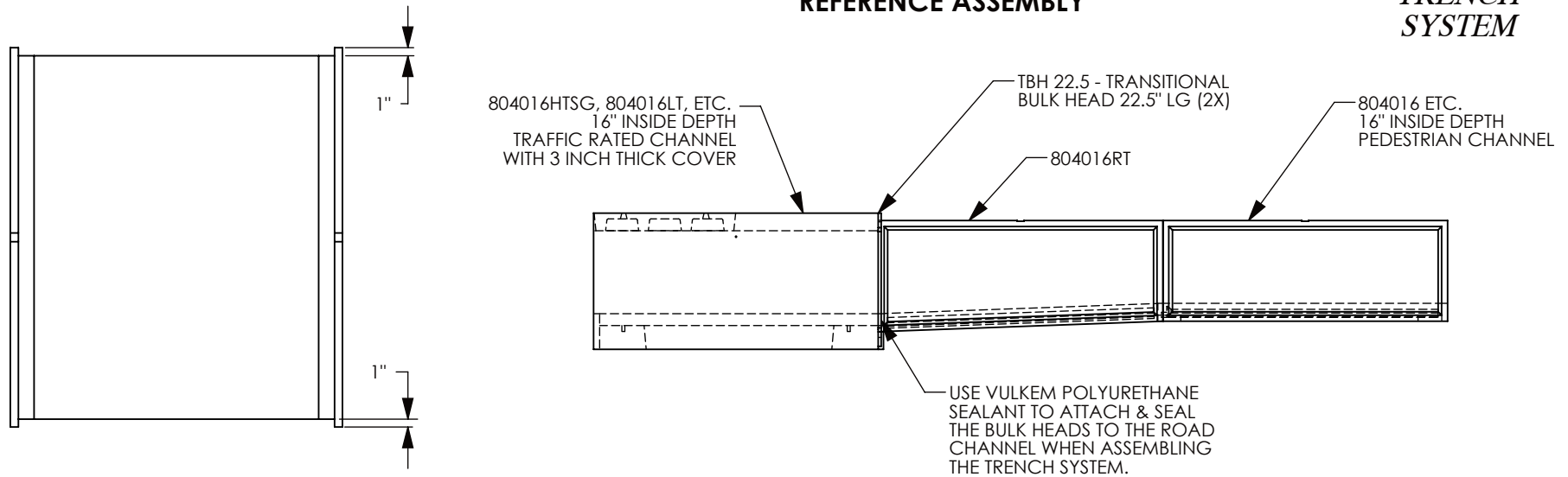
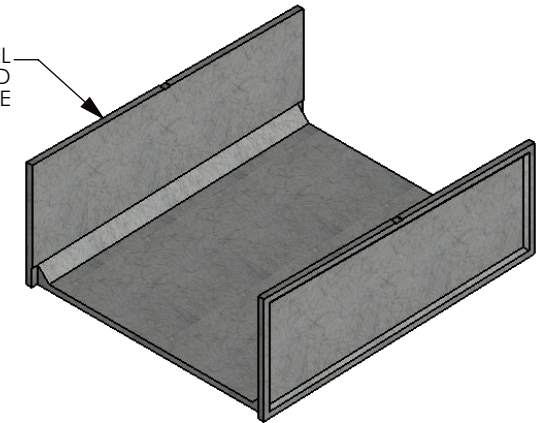

PEDESTRIAN RATED - 200 LB. PER SQ. FOOT

**DRAWN BY: ROBIN FLINT**

**DATE: 12/19/2011**

**REVISION LEVEL: 0**

**WEIGHT:**

**210 LBS.**

**MATERIAL:**

**FIBERCRETE**

**CONCAST**  
 1010 NORTH STAR DRIVE  
 P.O. BOX 69  
 ZUMBROTA, MN 55992-0069

**DESCRIPTION:**

**TRANSITION CHANNEL**

DIMENSIONS ARE IN INCHES  
 TOLERANCES:  
 FRACTIONAL: ± 1/8"  
 ANGULAR: ± 2°

CONTACT INFORMATION:  
 EMAIL: INFO@CONCASTINC.COM  
 PHONE: (507) 732-4095  
 FAX: (507) 732-4094

SHEET 1 OF 1

**PART NUMBER:**

**804016RT**