

FIBERCRETE®

FIBER REINFORCED CONCRETE

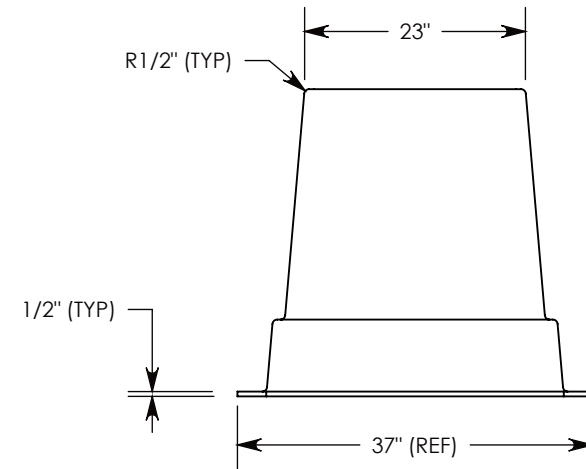
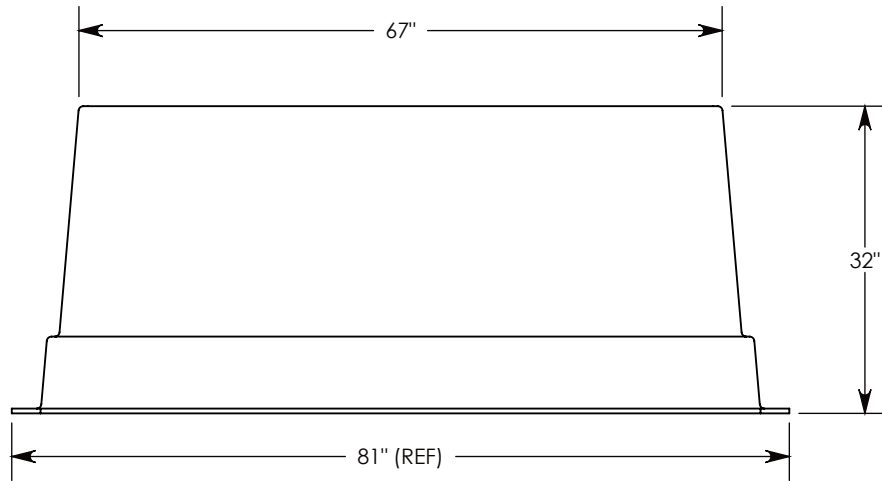
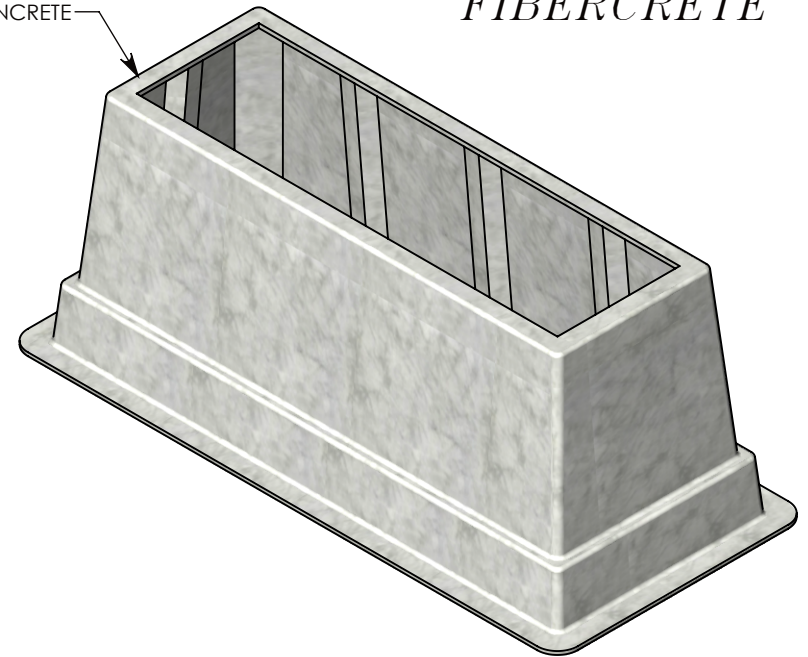
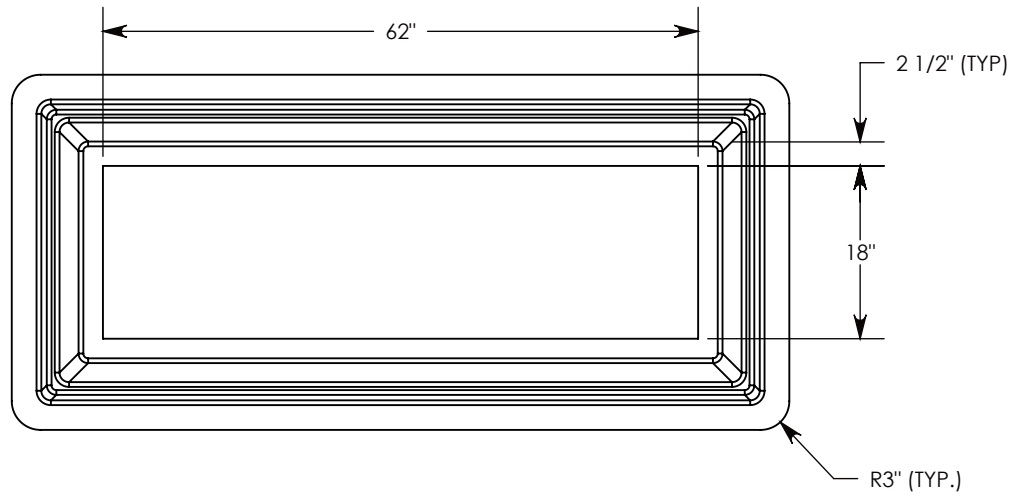

**DRAWN BY: ROBIN FLINT**

**DATE: 9/29/2016**

**REVISION LEVEL: 0**

**WEIGHT:**

**382 LBS.**

**MATERIAL:**

**FIBERCRETE FC**



1010 NORTH STAR DRIVE  
P.O. BOX 69  
ZUMBROTA, MN 55992-0069

**DESCRIPTION:**

**FIBERCRETE BOX PAD**

DIMENSIONS ARE IN INCHES

TOLERANCES:  
FRACTIONAL: ± 1/8"  
ANGULAR: ± 2°

CONTACT INFORMATION:  
EMAIL: INFO@CONCASTINC.COM  
PHONE: (507) 732-4095  
FAX: (507) 732-4094

SHEET 1 OF 1

**PART NUMBER:**

**FC-23-67-32-1862**