

REV. A - SIC - 10/22/2019 - 1/2"-13 LIFTING INSERT QTY: 4, WAS QTY: 3
 REV. B - SIC - 7/15/2020 - UPDATED WEIGHT RATING TO MAX H-40, WAS H-20; ADDED SOIL BEARING PRESSURES

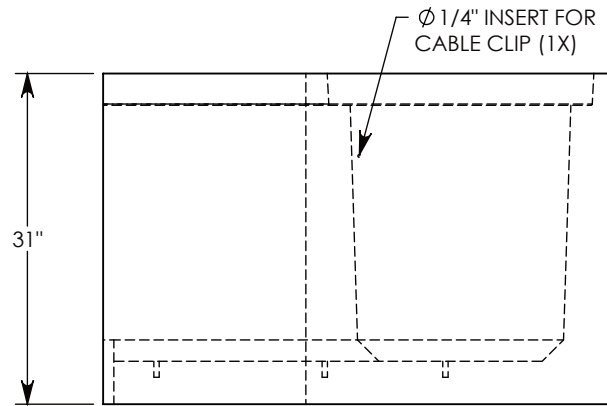
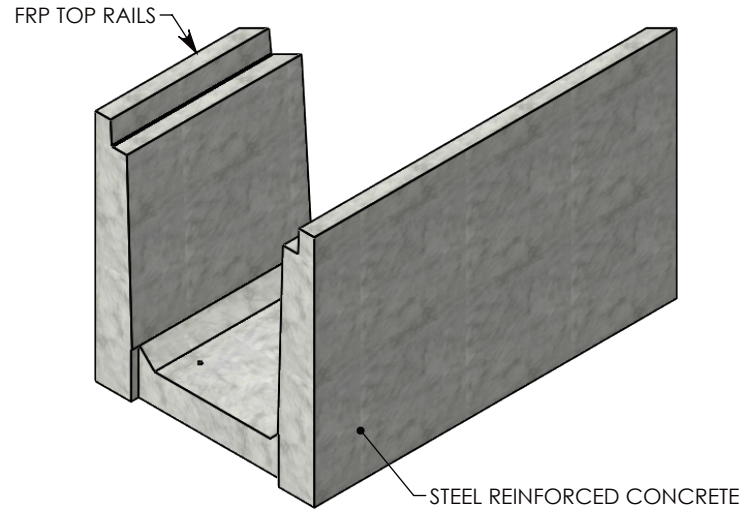
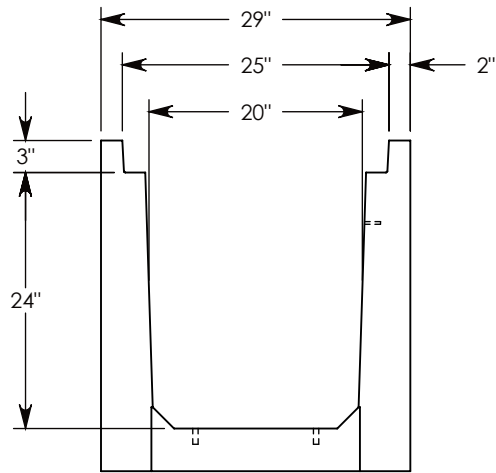
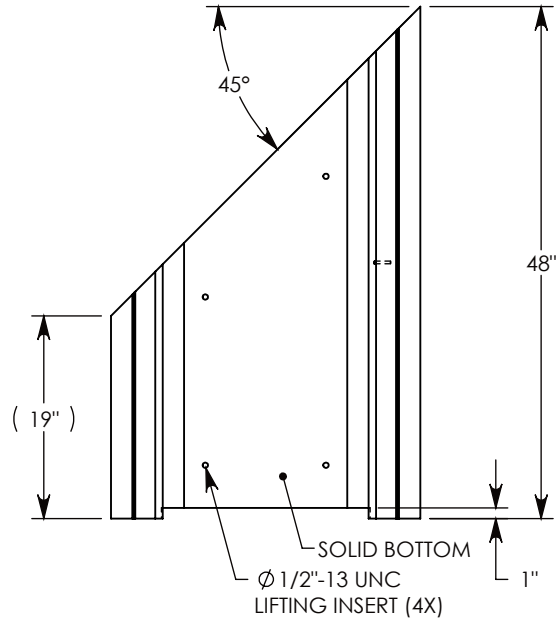

MAX AASHTO H-40 RATED - 64,000 LB. SINGLE AXLE LOAD
 DEPENDENT ON TRENCH COVER RATING
 MINIMUM ALLOWABLE SOIL BEARING PRESSURE - H-40: 4,000 PSF; H-20: 3,000 PSF

DRAWN BY: ROBIN FLINT	
CREATED DATE: 3/21/2011	REVISION LEVEL: B
SAVED DATE: 7/15/2020	SAVED BY: scallahan
WEIGHT: 953 LBS.	MATERIAL: CONCRETE

1010 NORTH STAR DRIVE
 P.O. BOX 69
 ZUMBROTA, MN 55992-0069

DESCRIPTION: HT CHANNEL; 45 DEG. ANGLE		SHEET 1 OF 1
DIMENSIONS ARE IN INCHES TOLERANCES: FRACTIONAL: ± 1/8" ANGULAR: ± 2°	CONTACT INFORMATION: EMAIL: INFO@CONCASTINC.COM PHONE: (507) 732-4095 FAX: (507) 732-4094	
PART NUMBER: HTF2024 45L		