

SIDE "A" (HLR)

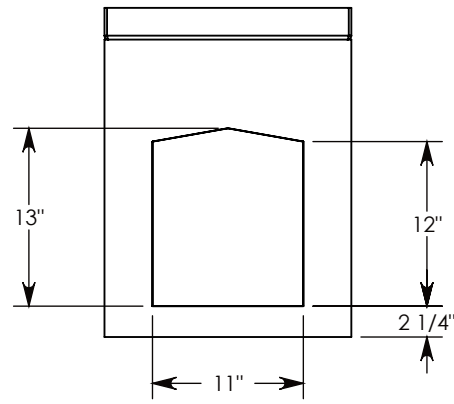

SIDE "B" (HLR)

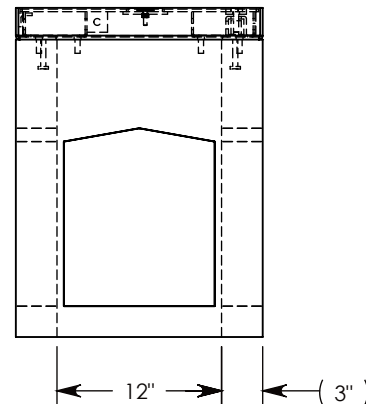

SIDE "C"

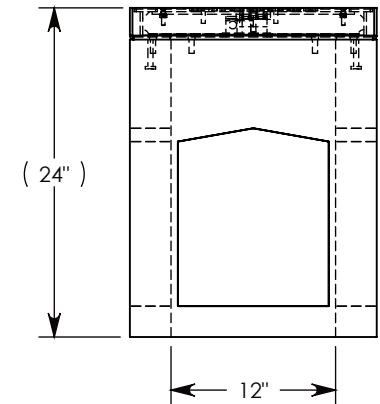

SIDE "D"

NOTE 1: FOR ADDED SECURITY, REPLACE PENTA HEAD BOLTS WITH SURELOCK BOLTS AND ORDER UNDER P/N: FHRSLFV-18-18-24

AASHTO H-20 RATED – 32,000 LB. SINGLE AXLE LOAD

DRAWN BY: JESSE GUTTING	
CREATED DATE: 4/21/2020	REVISION LEVEL: 0
SAVED DATE: 5/13/2021	SAVED BY: jgutting
WEIGHT: 244 LBS.	MATERIAL: NOTED



1010 NORTH STAR DRIVE
P.O. BOX 69
ZUMBROTA, MN 55992-0069

DESCRIPTION: HEAVY TRAFFIC HANDHOLE		SHEET 1 OF 1
DIMENSIONS ARE IN INCHES TOLERANCES: FRACTIONAL: ± 1/8" ANGULAR: ± 2°	CONTACT INFORMATION: EMAIL: INFO@CONCASTINC.COM PHONE: (507) 732-4095 FAX: (507) 732-4094	
PART NUMBER: FHRFV-18-18-24		