

Ø 1/2"-13 UNC INSERT (8X)
FOR BOLT DOWN

STEEL REINFORCED CONCRETE

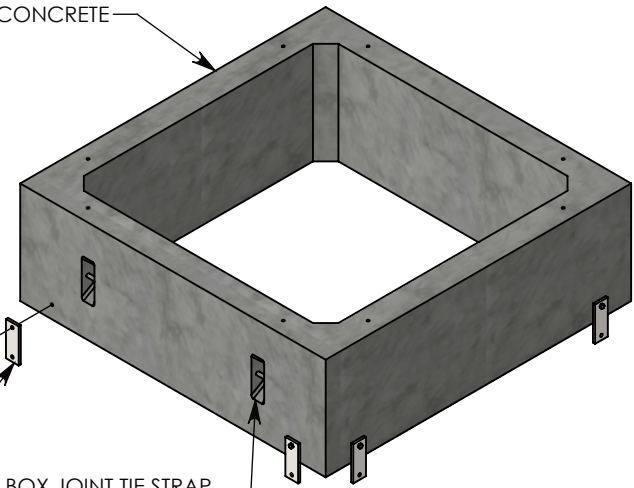

PULL BOX JOINT TIE STRAP
P/N: T-STRAP-1 (8X)

1/2-13 UNC X 1.5" LG HEX HD BOLT
P/N: HHB.5-1.5 (8X)

A-ANCHORS FOR LIFTING

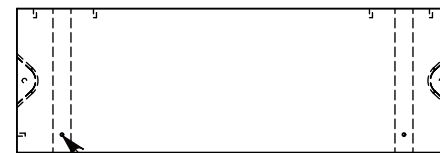
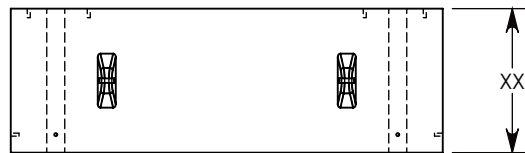

Ø 1/2"-13 UNC INSERT (8X)
FOR TIE STRAP

NOTE 1: XX CAN BE ANY HEIGHT, IN 1 INCH INCREMENTS, FROM 12" (MIN) TO 65" (MAX)
EX: A 24" EXTENSION WOULD BE NAMED PBEX-72-72-24

DRAWN BY: ROSS LAGER

DATE: 5/16/2019

REVISION LEVEL: 0

WEIGHT:

~ LBS.

MATERIAL:

NOTED



1010 NORTH STAR DRIVE
P.O. BOX 69
ZUMBROTA, MN 55992-0069

DESCRIPTION:

PULL BOX EXTENSION

DIMENSIONS ARE IN INCHES

TOLERANCES:
FRACTIONAL: ± 1/8"
ANGULAR: ± 2°

CONTACT INFORMATION:
EMAIL: INFO@CONCASTINC.COM
PHONE: (507) 732-4095
FAX: (507) 732-4094

SHEET 1 OF 1

PART NUMBER:

PBEX-72-72-XX