

FIBERCRETE®

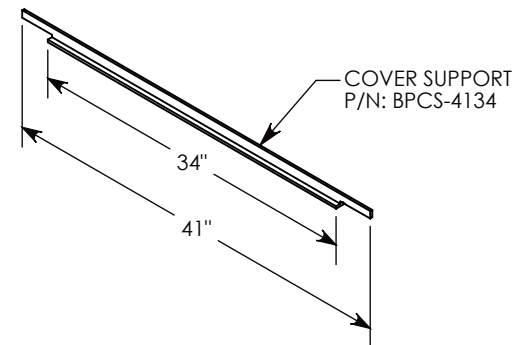
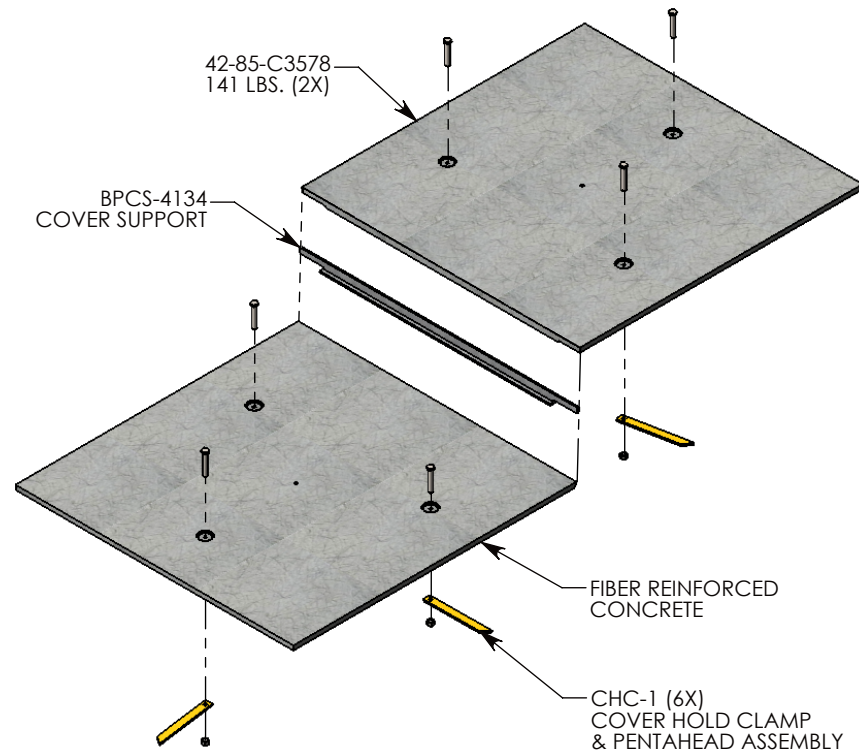
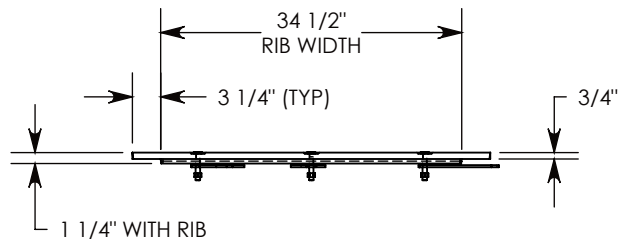
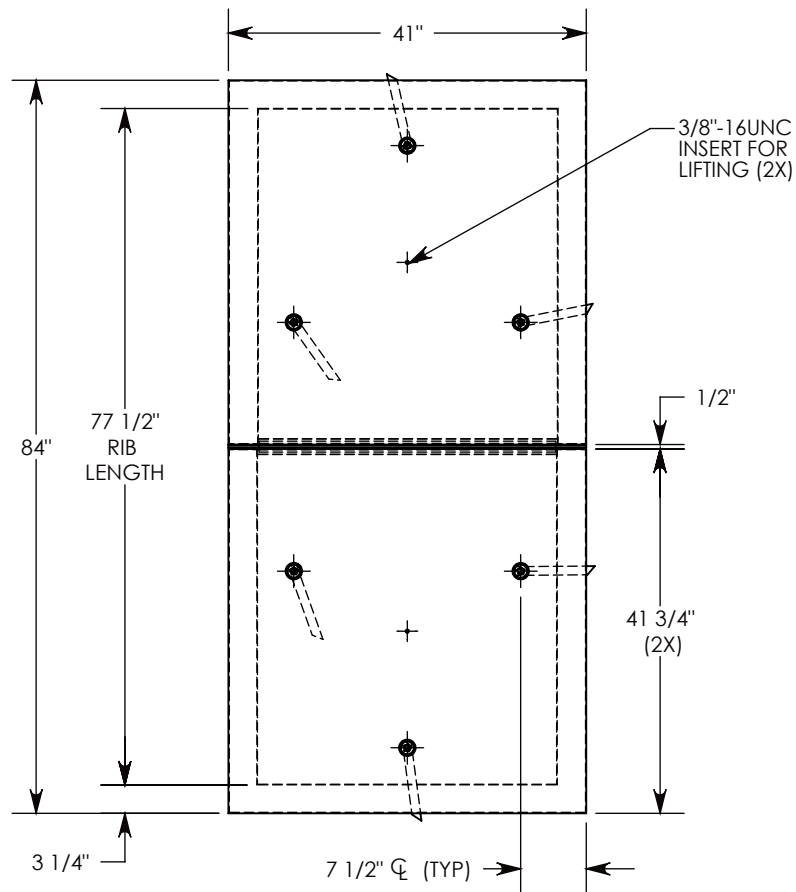

DRAWN BY: ROBIN FLINT

DATE: 7/10/2012

REVISION LEVEL: 0

WEIGHT:

293 LBS. TOTAL

MATERIAL:

FIBERCRETE

CONCAST
 1010 NORTH STAR DRIVE
 P.O. BOX 69
 ZUMBROTA, MN 55992-0069

DESCRIPTION:

FIBERCRETE BOX PAD COVERS

DIMENSIONS ARE IN INCHES
 TOLERANCES:
 FRACTIONAL: ± 1/8"
 ANGULAR: ± 2°

CONTACT INFORMATION:
 EMAIL: INFO@CONCASTINC.COM
 PHONE: (507) 732-4095
 FAX: (507) 732-4094

SHEET 1 OF 1

PART NUMBER:

42-85-C3578