

FIBERCRETE[®]
TRENCH
SYSTEM

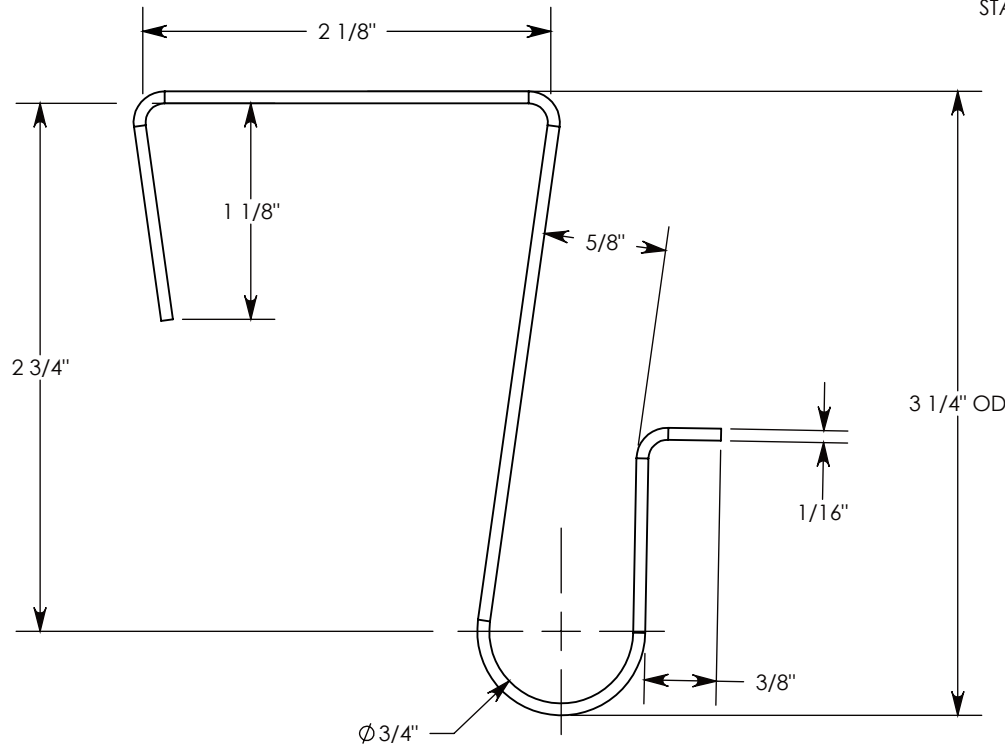

STAINLESS STEEL

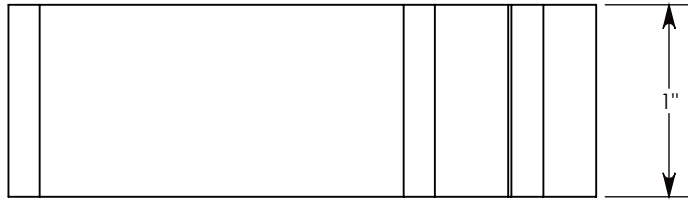
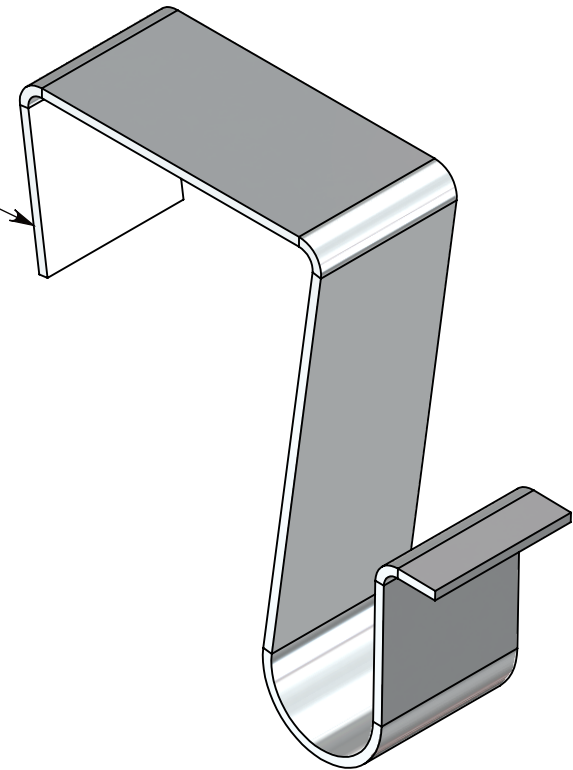

CHANNELS ARE NOTCHED FOR GROUND CABLE CLIPS.

DRAWN BY: ROBIN FLINT

DATE: 8/8/2015

REVISION LEVEL: 0

WEIGHT:

0.2 LBS.

MATERIAL:

STAINLESS STEEL



1010 NORTH STAR DRIVE
 P.O. BOX 69
 ZUMBROTA, MN 55992-0069

DESCRIPTION:

PEDESTRIAN PT CHANNEL CABLE CLIP

DIMENSIONS ARE IN INCHES
 TOLERANCES:
 FRACTIONAL: $\pm 1/8"$
 ANGULAR: $\pm 2^\circ$

CONTACT INFORMATION:
 EMAIL: INFO@CONCASTINC.COM
 PHONE: (507) 732-4095
 FAX: (507) 732-4094

PART NUMBER: 8002PT-001

SHEET 1 OF 1