

FIBERCRETE[®]
TRENCH SYSTEM

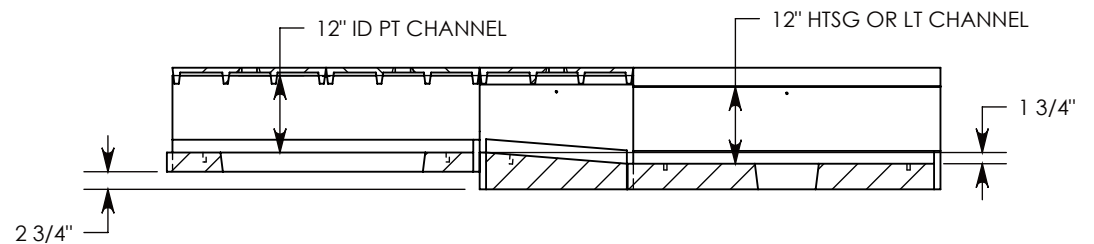
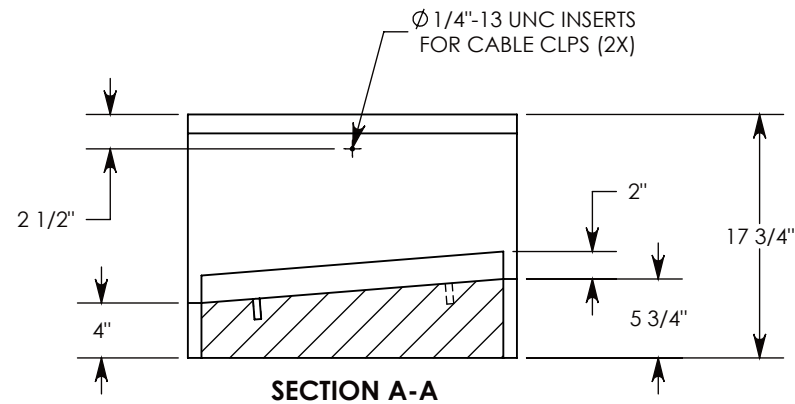
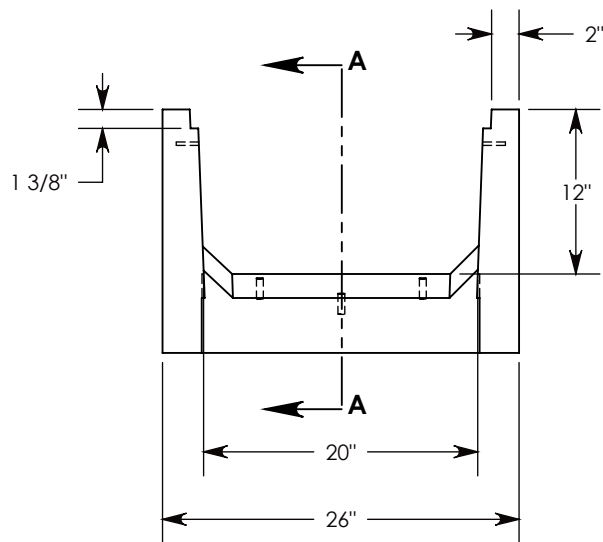
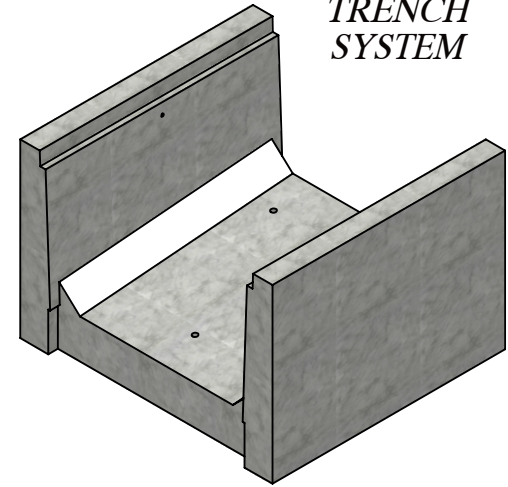
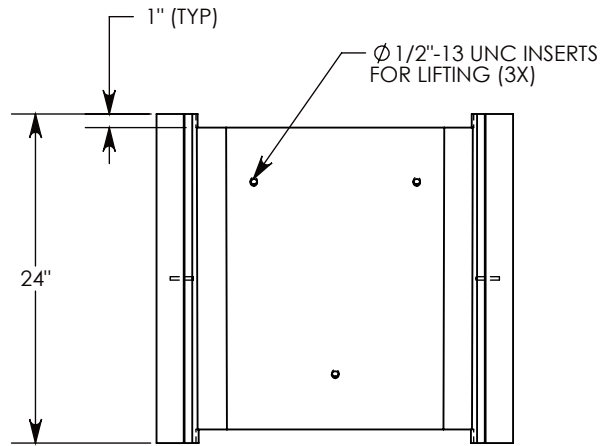

NOTE 1: PEDESTRIAN RATED - 200 LB. PER SQ. FOOT

REF. SECTION VIEW OF TRANSITION CHANNEL ASSEMBLY

DRAWN BY: ROBIN FLINT

DATE: 1/26/2015

REVISION LEVEL: 0

WEIGHT:

379 LBS.

MATERIAL:

CONCRETE

CONCAST
 1010 NORTH STAR DRIVE
 P.O. BOX 69
 ZUMBROTA, MN 55992-0069

DESCRIPTION:

PT TRANSITION CHANNEL TO HTSG OR LT

DIMENSIONS ARE IN INCHES
 TOLERANCES:
 FRACTIONAL: $\pm 1/8$ "
 ANGULAR: $\pm 2^\circ$

CONTACT INFORMATION:
 EMAIL: INFO@CONCASTINC.COM
 PHONE: (507) 732-4095
 FAX: (507) 732-4094

SHEET 1 OF 1

PART NUMBER:

8020PTRT2