

FIBERCRETE[®]
TRENCH
SYSTEM

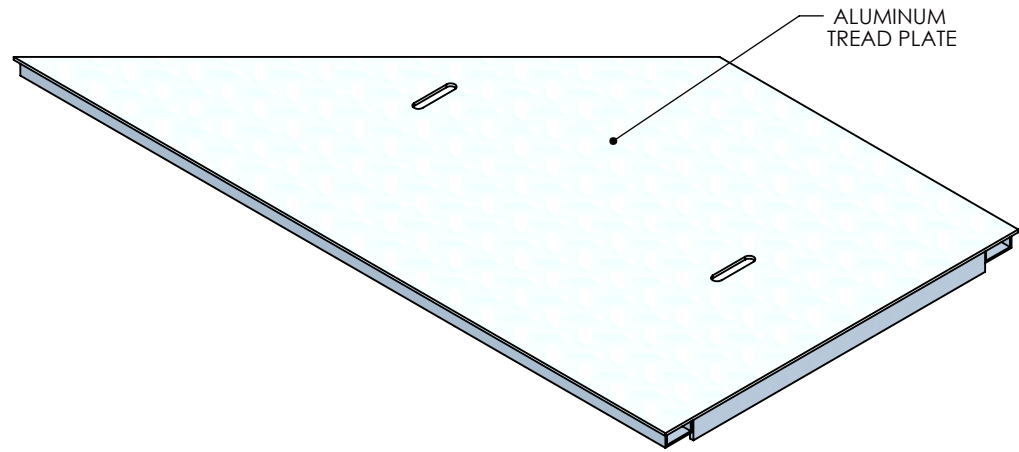

COVER ASSEMBLES ONTO 20" INSIDE WIDTH PEDESTRIAN RATED CONCAST PT CHANNEL

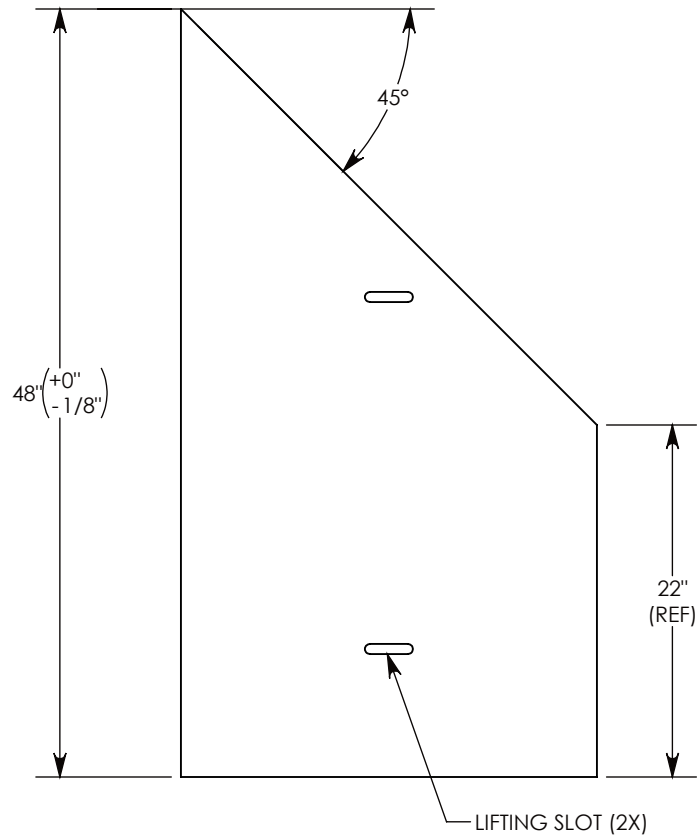
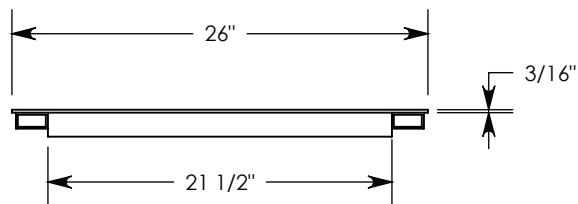

NOTE 1: FOR NON-STANDARD LENGTHS THE PART NUMBER WILL CORRESPOND TO IT'S MEASURED LENGTH. IE: 8021PTAT_45R 36"

PEDESTRIAN RATED - 200 LB. PER SQ. FOOT

DRAWN BY: ROBIN FLINT

DATE: 11/28/2015

REVISION LEVEL: 0

WEIGHT:

26 LBS.

MATERIAL:

WELDED ALUMINUM



DESCRIPTION:

ALUMINUM COVER - 45 DEGREE ANGLE

DIMENSIONS ARE IN INCHES
 TOLERANCES:
 FRACTIONAL: ± 1/8"
 ANGULAR: ± 2°

CONTACT INFORMATION:
 EMAIL: INFO@CONCASTINC.COM
 PHONE: (507) 732-4095
 FAX: (507) 732-4094

SHEET 1 OF 2

PART NUMBER:

8021PTAT 45R