

FIBERCRETE[®]
TRENCH
SYSTEM

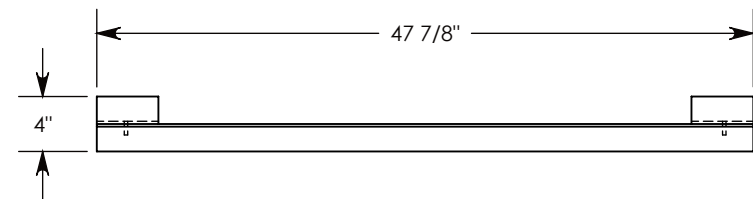
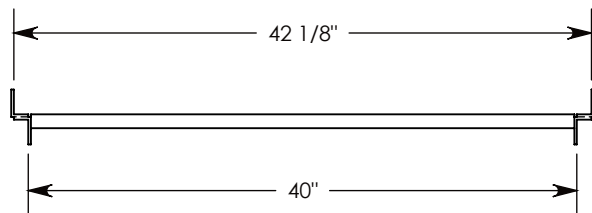
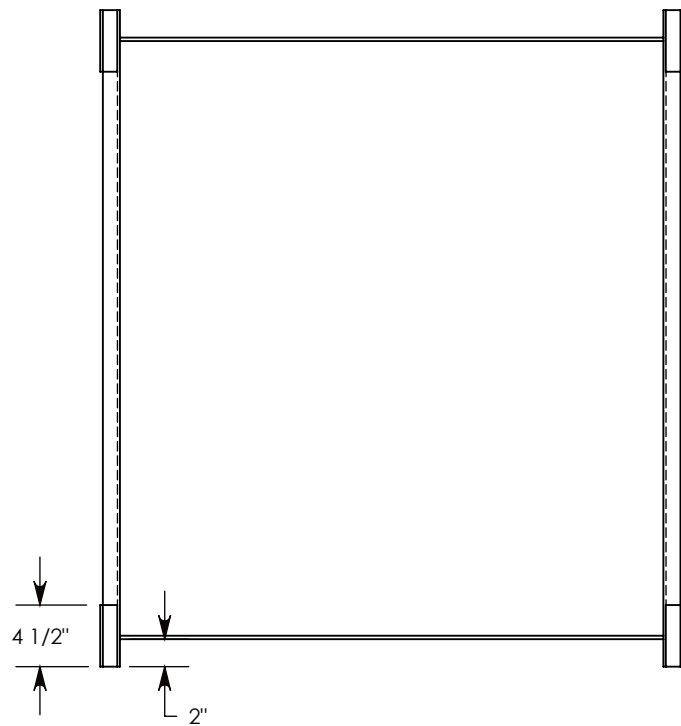
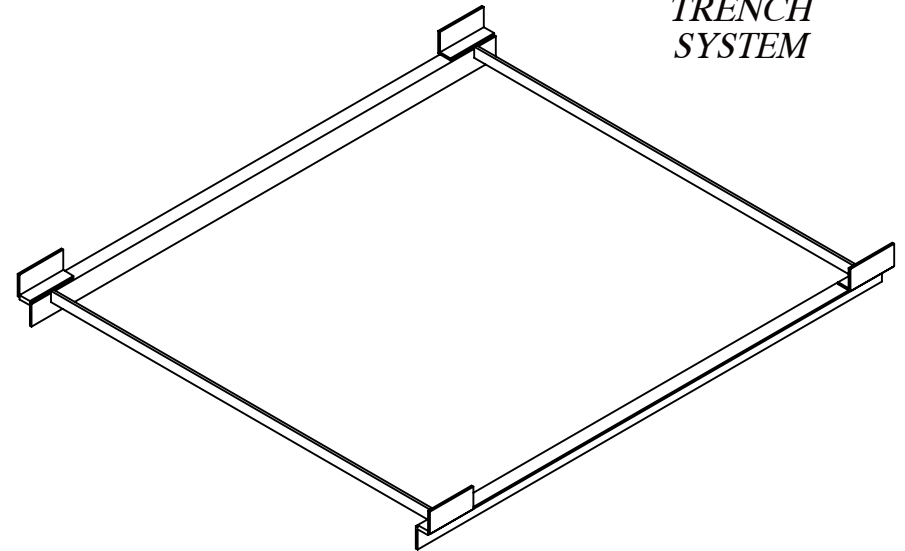

DRAWN BY: ROBIN FLINT

DATE: 1/20/2012

REVISION LEVEL: 0

WEIGHT:

8 LBS.

MATERIAL:

WELDED ALUMINUM



1010 NORTH STAR DRIVE
 P.O. BOX 69
 ZUMBROTA, MN 55992-0069

DESCRIPTION:

TRENCH SUPPORT

DIMENSIONS ARE IN INCHES

TOLERANCES:
 FRACTIONAL: $\pm 1/8"$
 ANGULAR: $\pm 2^\circ$

CONTACT INFORMATION:
 EMAIL: INFO@CONCASTINC.COM
 PHONE: (507) 732-4095
 FAX: (507) 732-4094

PART NUMBER: 8040TS

SHEET 1 OF 1