

FIBERCRETE®

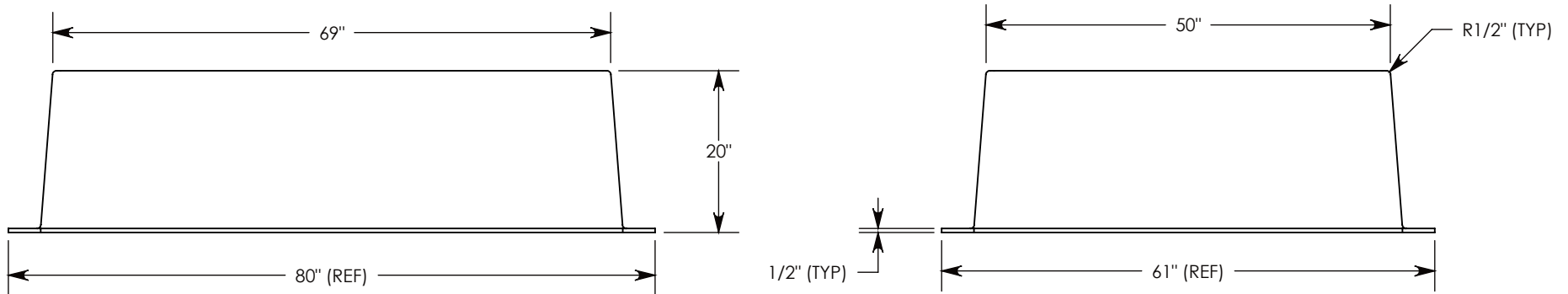
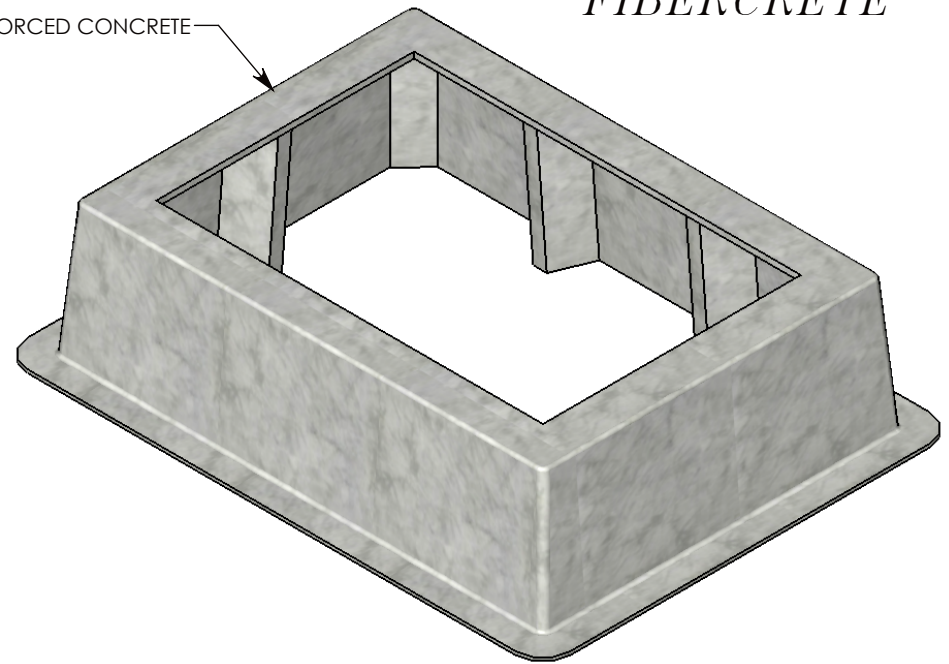
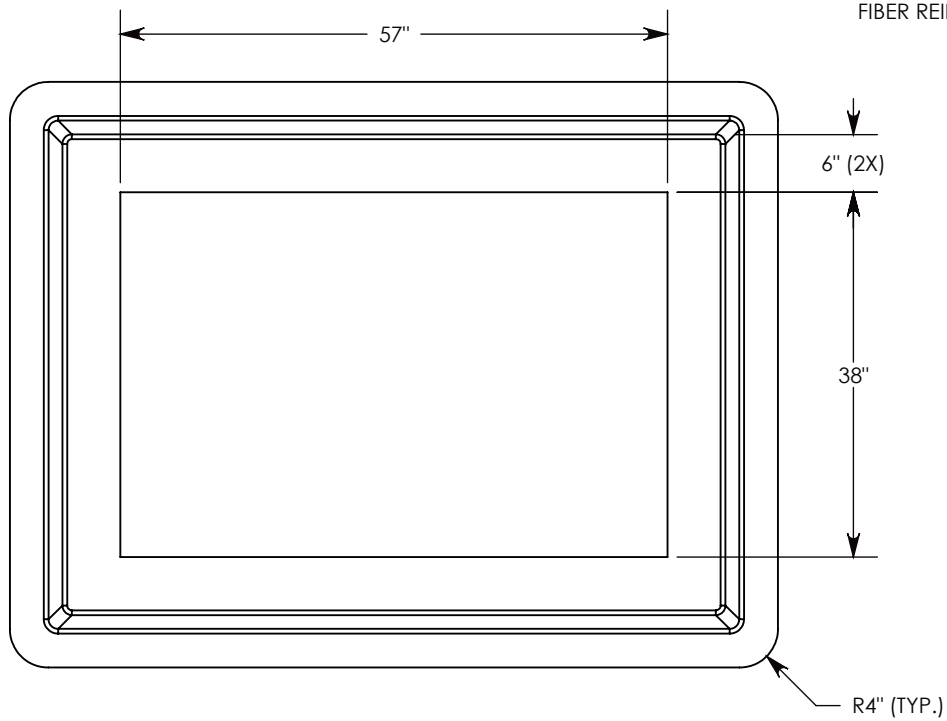

DRAWN BY: ROBIN FLINT

DATE: 3/22/2013

REVISION LEVEL: 0

WEIGHT:

411 LBS.

MATERIAL:

FIBERCRETE FC



DESCRIPTION:

FIBERCRETE BOX PAD

DIMENSIONS ARE IN INCHES
TOLERANCES:
FRACTIONAL: ± 1/8"
ANGULAR: ± 2°

CONTACT INFORMATION:
EMAIL: INFO@CONCASTINC.COM
PHONE: (507) 732-4095
FAX: (507) 732-4094

SHEET 1 OF 1

PART NUMBER:

FC-50-69-20-3857