

FIBERCRETE®

FIBER REINFORCED CONCRETE

EXCLUDING THE FINS, THE REAR TRANSFORMER SUPPORT MUST BE WITHIN 6" OF THIS EDGE.

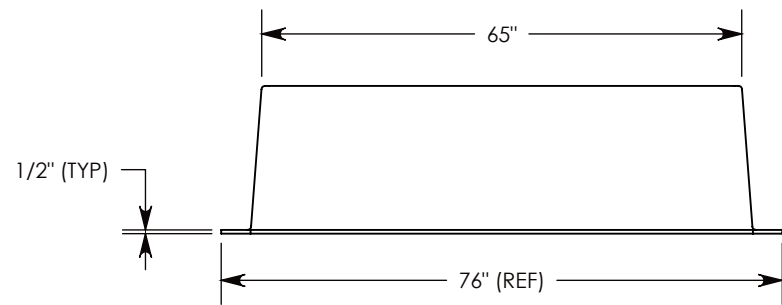
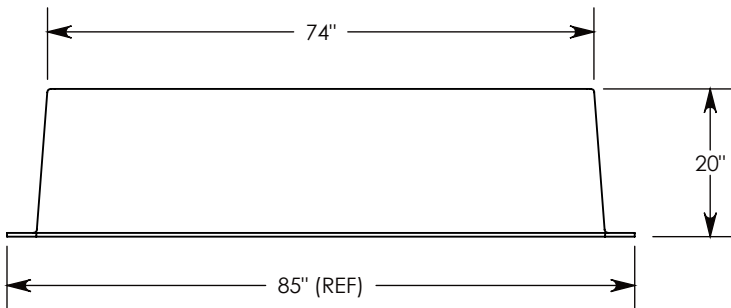
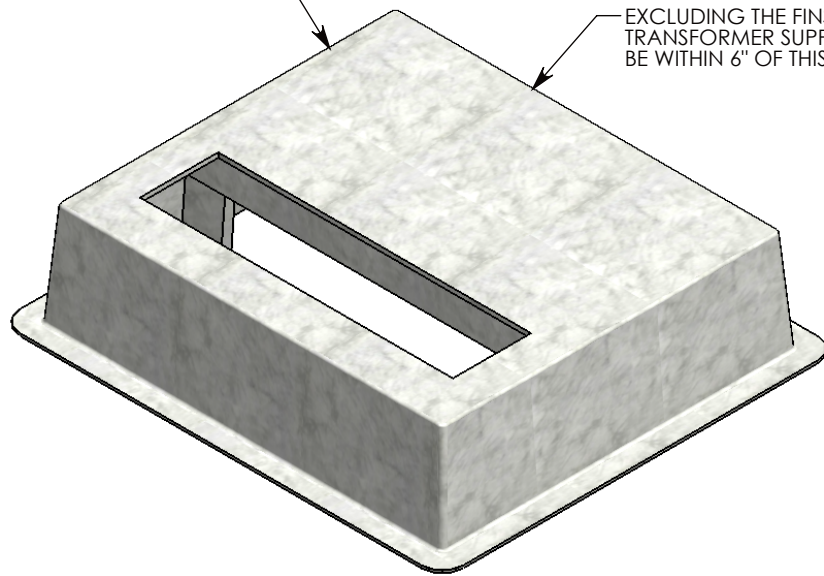
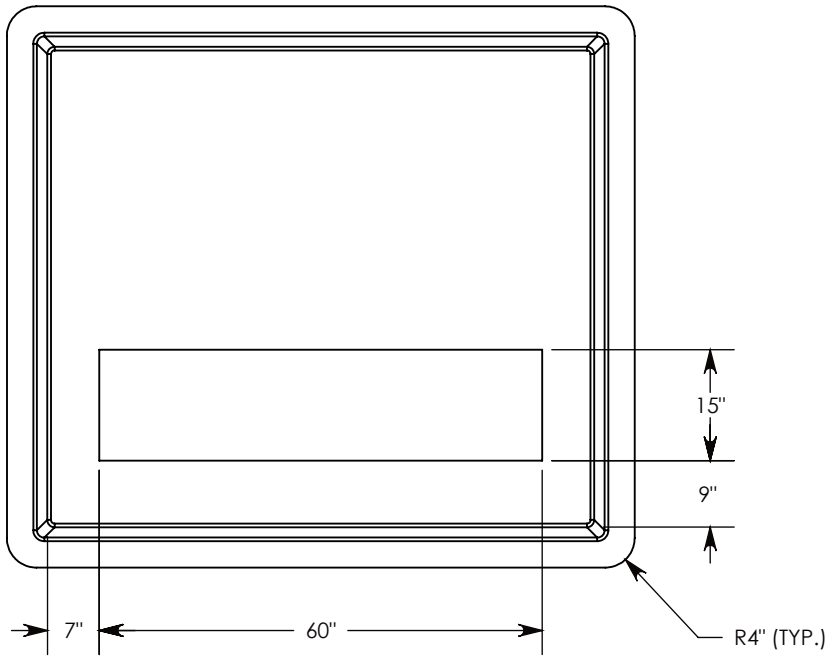

Ø 1/2"-13 UNC LIFTING INSERTS WILL BE CAST INTO BOX PAD
IF SPECIFIC INSERTS OR MOUNTING HARDWARE ARE REQUIRED, PLEASE SPECIFY WHEN ORDERING.

DRAWN BY: ROBIN FLINT	
DATE: 6/12/2012	REVISION LEVEL: 0
WEIGHT: 834 LBS.	MATERIAL: FIBERCRETE FC



CONCAST
1010 NORTH STAR DRIVE
P.O. BOX 69
ZUMBROTA, MN 55992-0069

DESCRIPTION: FIBERCRETE PAD BOX		
DIMENSIONS ARE IN INCHES TOLERANCES: FRACTIONAL: ± 1/8" ANGULAR: ± 2°	CONTACT INFORMATION: EMAIL: INFO@CONCASTINC.COM PHONE: (507) 732-4095 FAX: (507) 732-4094	SHEET 1 OF 1
PART NUMBER: FC-65-74-20-1560 (9)		