

FIBERCRETE®

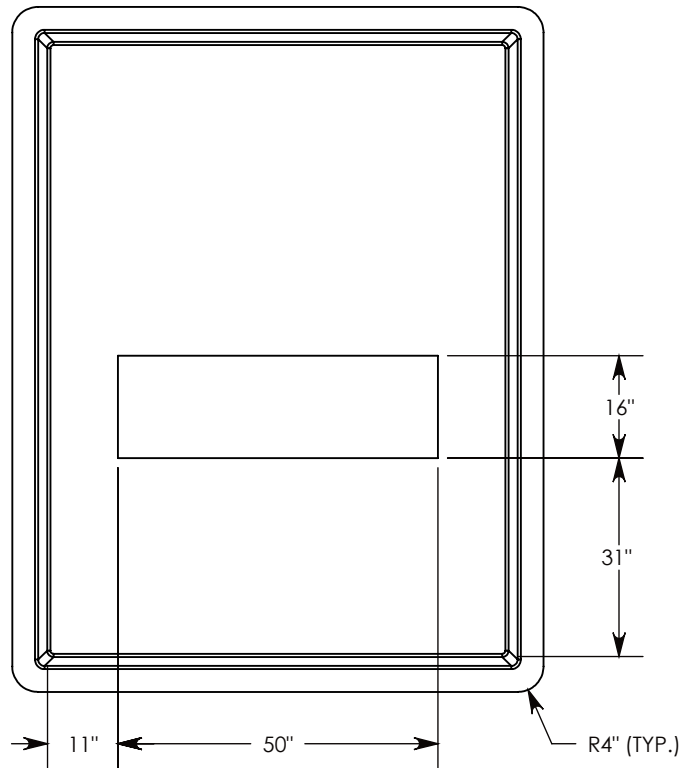

FIBER REINFORCED CONCRETE

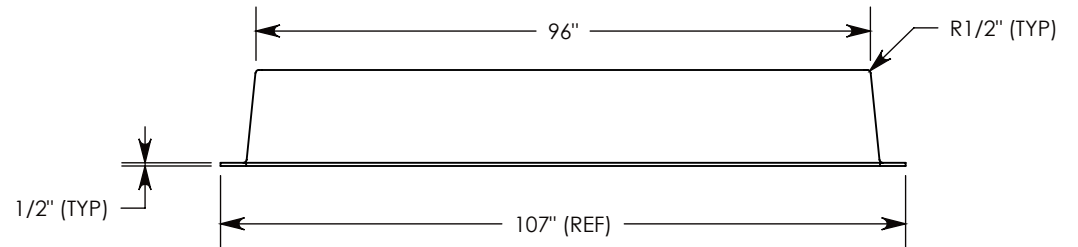
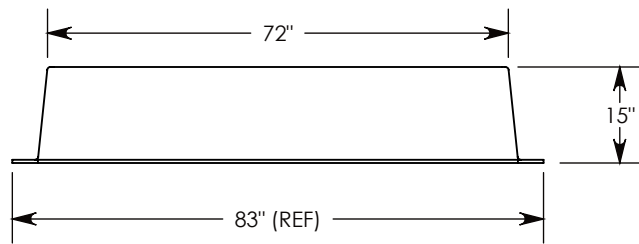
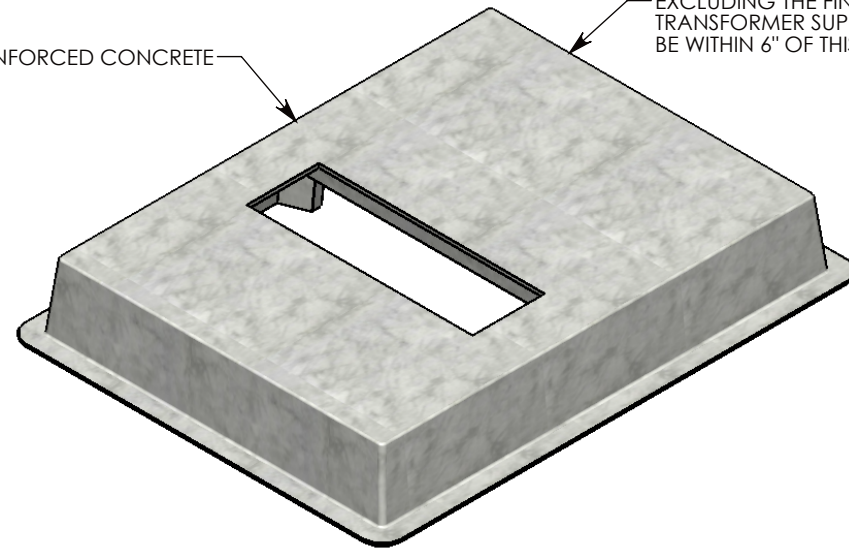

Ø 1/2"-13 UNC LIFTING INSERTS WILL BE CAST INTO BOX PAD
IF SPECIFIC INSERTS OR MOUNTING HARDWARE ARE REQUIRED, PLEASE SPECIFY WHEN ORDERING.

DRAWN BY: ROBIN FLINT

DATE: 6/19/2012

REVISION LEVEL: 0

WEIGHT:

944 LBS.

MATERIAL:

FIBERCRETE FC

CONCAST
1010 NORTH STAR DRIVE
P.O. BOX 69
ZUMBROTA, MN 55992-0069

DESCRIPTION:

FIBERCRETE PAD BOX

DIMENSIONS ARE IN INCHES
TOLERANCES:
FRACTIONAL: ± 1/8"
ANGULAR: ± 2°

CONTACT INFORMATION:
EMAIL: INFO@CONCASTINC.COM
PHONE: (507) 732-4095
FAX: (507) 732-4094

SHEET 1 OF 1

PART NUMBER:

FC-72-96-15-5016 (31)