

ITEM NO.	PART NUMBER	DESCRIPTION	QTY.
1	CCSCREW-1.25	1/4" X 1.25" LONG CONCRETE SCREW	4
2	DIV-BKT.W	1/2" ALUMINUM SLEEVE	2
3	FHR-24-24-DIV.B	FHR DIVIDER BOARD	1

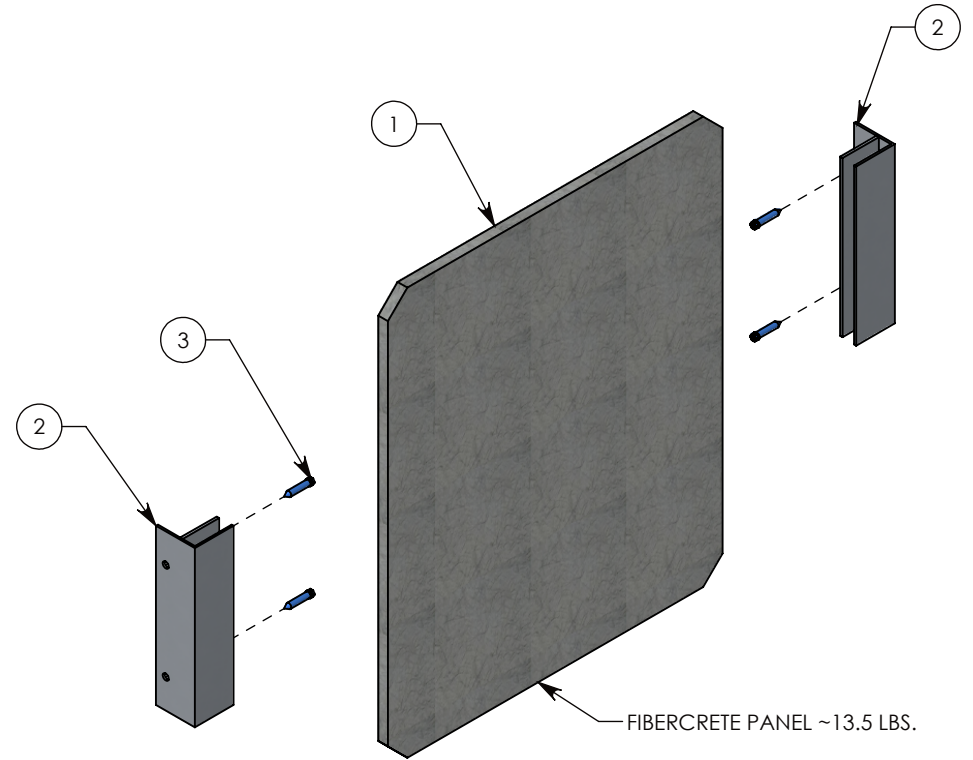

NOTE: DESIGNED TO CREATE SEPARATION IN A 24" WIDE BY 24" TALL CONCAST FHR HANDHOLE UNIT.

DRAWN BY: ROBIN FLINT	
DATE: 10/31/2015	REVISION LEVEL: 0
WEIGHT: 15 LBS. WITH HARDWARE	MATERIAL: NOTED

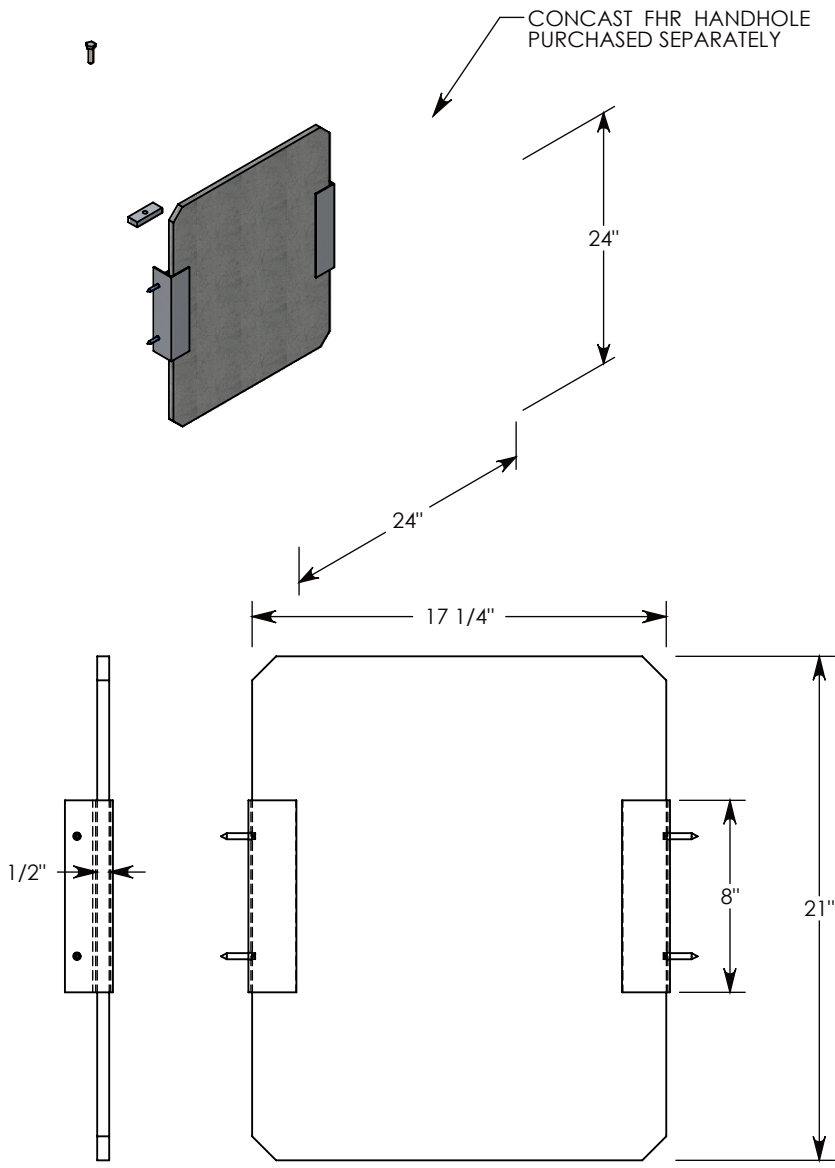

1010 NORTH STAR DRIVE
P.O. BOX 69
ZUMBROTA, MN 55992-0069

DESCRIPTION: FHR DIVIDER PANEL	
DIMENSIONS ARE IN INCHES TOLERANCES: FRACTIONAL: ± 1/8" ANGULAR: ± 2°	CONTACT INFORMATION: EMAIL: INFO@CONCASTINC.COM PHONE: (507) 732-4095 FAX: (507) 732-4094
PART NUMBER: FHR-24-24-DIV	
SHEET 1 OF 1	