

ITEM NO.	PART NUMBER	DESCRIPTION	QTY.
1	CCSCREW-1.25	1/4" X 1.25" LONG CONCRETE SCREW	4
2	DIV-BKT.W	1/2" ALUMINUM SLEEVE	2
3	FHR-36-24-DIV.B	FHR DIVIDER BOARD	1

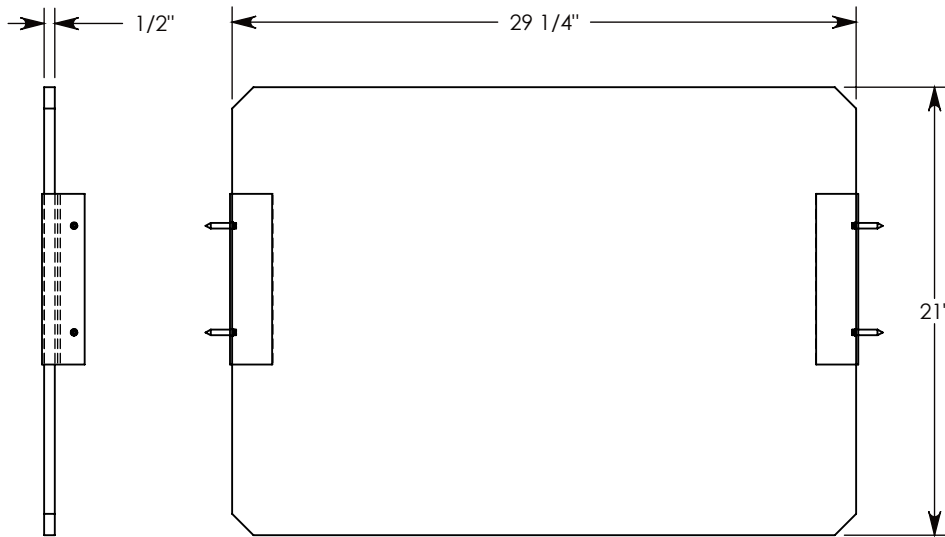
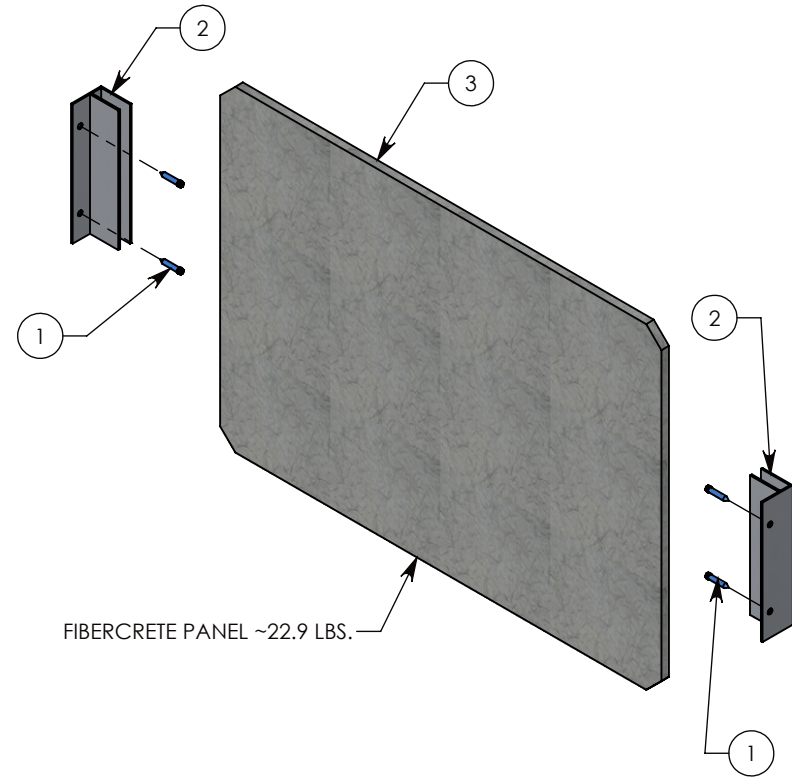
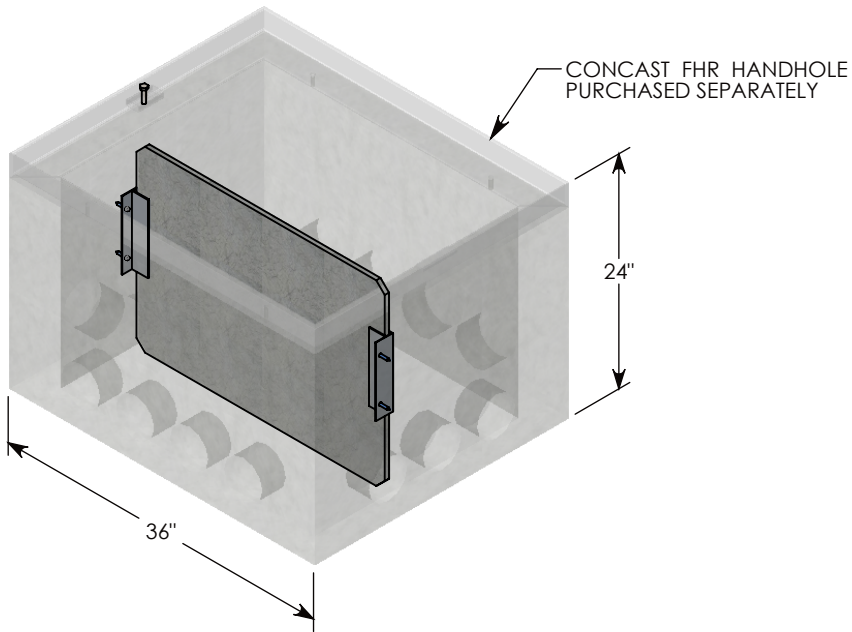

NOTE: DESIGNED TO CREATE SEPARATION IN A 36" WIDE BY 24" TALL CONCAST FHR HANDHOLE UNIT.

DRAWN BY: ROBIN FLINT

DATE: 10/31/2015

REVISION LEVEL: 0

WEIGHT:
24 LBS.
WITH HARDWARE

MATERIAL:
NOTED



DESCRIPTION:

FHR DIVIDER PANEL

DIMENSIONS ARE IN INCHES
TOLERANCES:
FRACTIONAL: ± 1/8"
ANGULAR: ± 2°

CONTACT INFORMATION:
EMAIL: INFO@CONCASTINC.COM
PHONE: (507) 732-4095
FAX: (507) 732-4094

SHEET 1 OF 1

PART NUMBER:

FHR-36-24-DIV