

ITEM NO.	PART NUMBER	DESCRIPTION	QTY.
1	FRP4B	FRP DIVIDER BASE	1
2	FRP4P10.25	DIVIDER PANEL	1
3	APB25-1.25	ANCHOR PIN BOLT	4

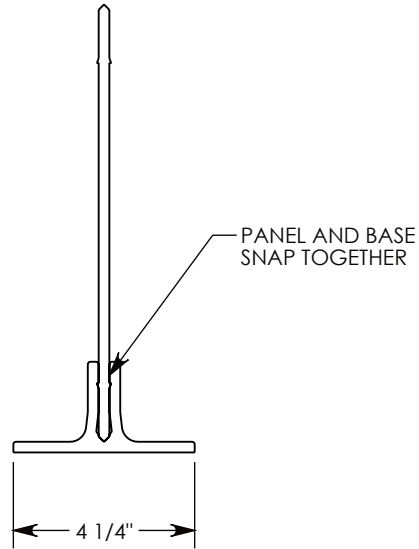

DETAIL A
SCALE 2 : 9

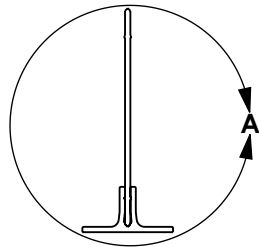
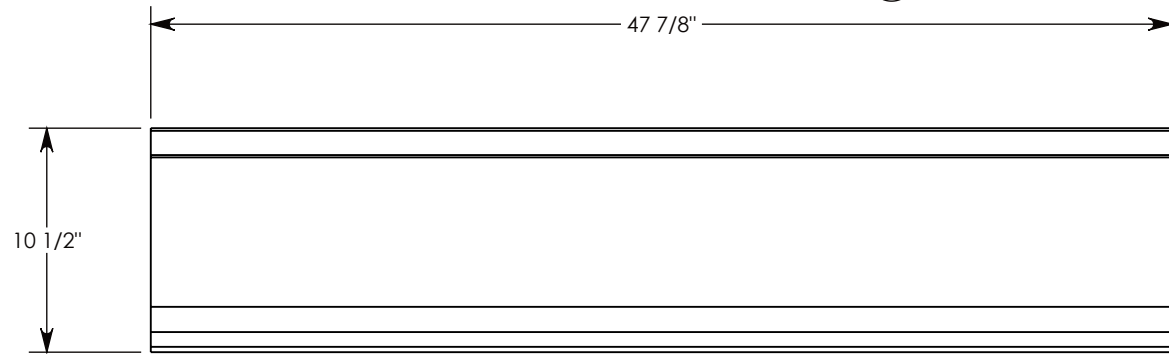
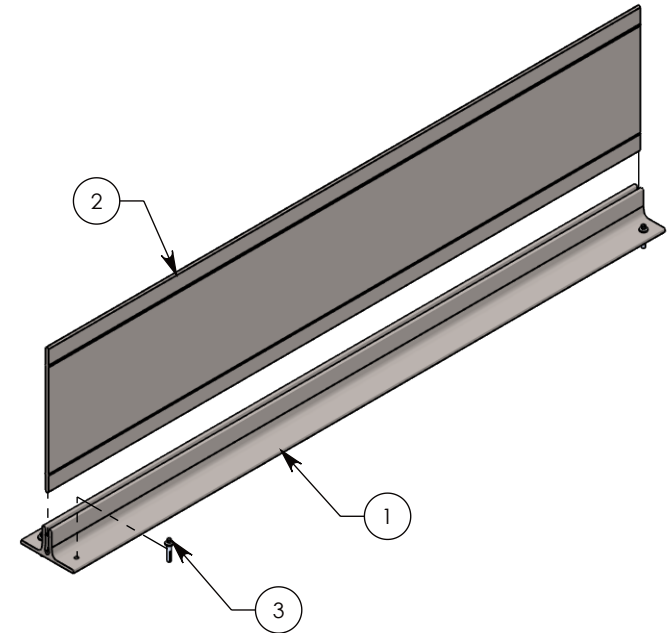

NOTE 1: FRP4B IS DRILLED AND INSTALLED IN CHANNEL USING APB-1.25

DRAWN BY: **JESSE GUTTING**

CREATED DATE: **2/12/2024** REVISION LEVEL: **0**

SAVED DATE: **2/12/2024** SAVED BY: **jgutting**

WEIGHT: **14 LBS.** MATERIAL: **FRP**

CONCAST
1010 NORTH STAR DRIVE
P.O. BOX 69
ZUMBROTA, MN 55992-0069

DESCRIPTION:

FRP DIVIDER ASSEMBLY

DIMENSIONS ARE IN INCHES
TOLERANCES:
FRACTIONAL: $\pm 1/8"$
ANGULAR: $\pm 2^\circ$

CONTACT INFORMATION:
EMAIL: INFO@CONCASTINC.COM
PHONE: (507) 732-4095
FAX: (507) 732-4094

SHEET 1 OF 1

PART NUMBER:

FRP4D10.5