

3/8-16 UNC X 2.5" LG HEX HD BOLT (2X)
P/N: HHB.38-2.5

1/2-13 UNC X 1.5" LG HEX HD BOLT (4X)
P/N: HHB.5-1.5

BOLT-DOWN ALUMINUM FRAME & HA COVER
~148 LBS
P/N: 38-62-HA

CONCRETE PULL BOX
~2973 LBS
P/N: PB4-38-62-42

CON-DUCT TERMINATIONS ARE CAST INTO BOX SIDEWALLS. 4 PER SIDE THEY FIT UP TO 4" PVC PIPE. TO ACCESS THE HOLES, BREAK THE PLASTIC SEAL.

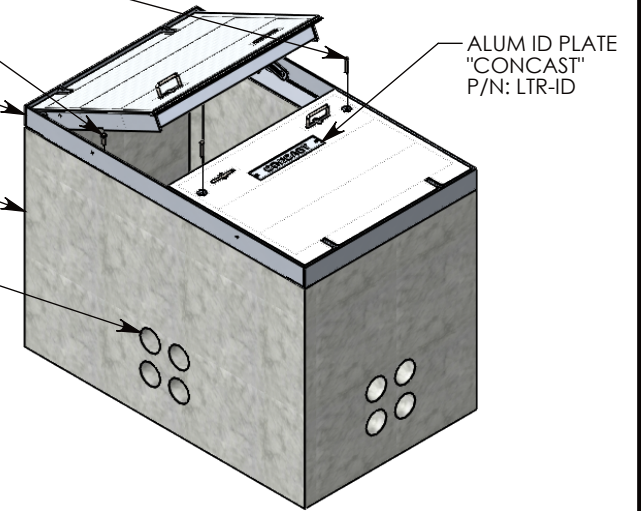

Ø 1/2"-13 UNC INSERT (4X) FOR PULLING EYES. LOCATED ON BOX INTERIOR (1X PER SIDE)

LIFT RING (4X) SHOWN EXTENDED

COVER SHOWN IN THIS VIEW

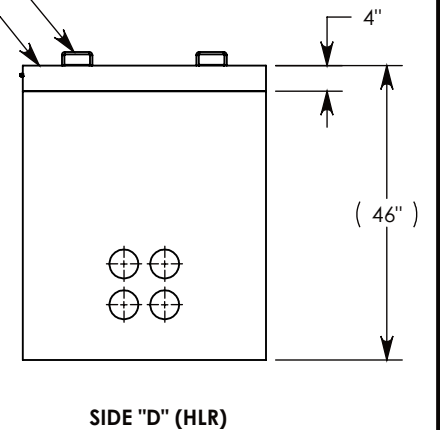
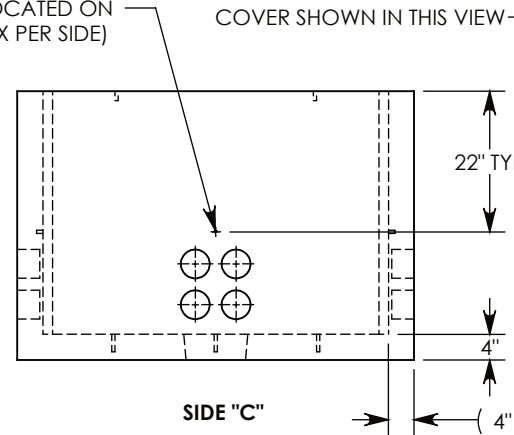
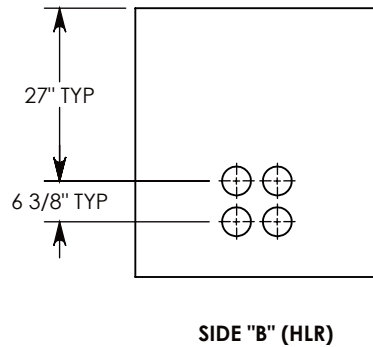
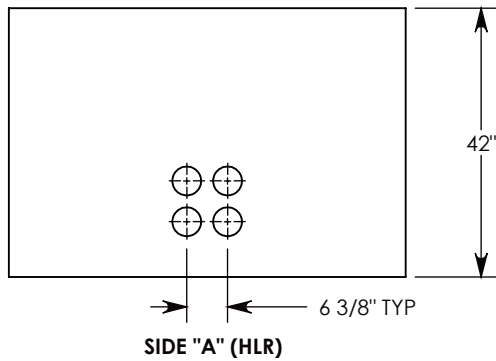

NOTE 1: FOR PVC SIZES SMALLER THAN 4", USE CONCAST RC41 (REDUCING COUPLER).

NOTE 2: FOR ADDED SECURITY, PENTA HEAD (P/N: PTA.38-2.5) OR SURELOCK BOLTS (P/N: SL.38-2.5) CAN BE ADDED

PEDESTRIAN RATED - 200 LB. PER SQ. FOOT

DRAWN BY: MALACHI MLINAR	
DATE: 3/12/2019	REVISION LEVEL: 0
WEIGHT: 3122 LBS.	MATERIAL: NOTED

1010 NORTH STAR DRIVE
P.O. BOX 69
ZUMBROTA, MN 55992-0069

DESCRIPTION: CONCRETE PULL BOX W/ HA COVER		
DIMENSIONS ARE IN INCHES TOLERANCES: FRACTIONAL: ± 1/8" ANGULAR: ± 2°	CONTACT INFORMATION: EMAIL: INFO@CONCASTINC.COM PHONE: (507) 732-4095 FAX: (507) 732-4094	SHEET 1 OF 1
PART NUMBER: PB4-38-62-42-HA		