

1/2-13 UNC X 1.5" LG HEX HD BOLT (4X)  
P/N: HHB.5-1.5

PEDESTRIAN RATED  
ALUMINUM COVER (2X)  
~48 LBS  
P/N: 44-34-A

ALUM. ID PLATE (2X)  
"CONCAST"  
P/N: LTR-ID

CONCRETE PULL BOX  
~5454 LBS  
P/N: PB4-44-68-72

CON-DUCT TERMINATIONS ARE CAST  
INTO BOX SIDEWALLS. 9 PER SIDE (4X)  
THEY FIT UP TO 4" PVC PIPE. TO ACCESS  
THE HOLES, BREAK THE PLASTIC SEAL

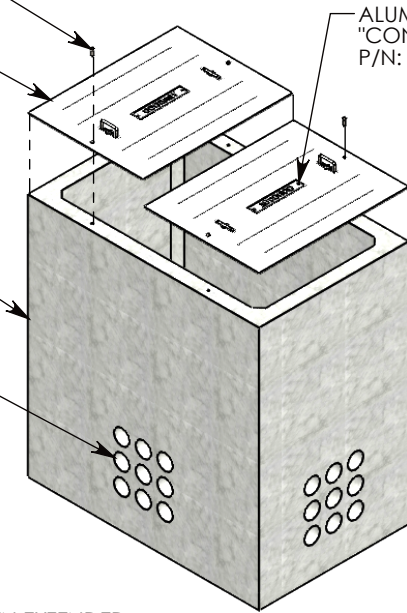

Ø 1/2"-13 UNC INSERT (4X) FOR  
PULLING EYES. LOCATED ON  
BOX INTERIOR (1X PER SIDE)

LIFTING RING SHOWN EXTENDED  
COVER SHOWN IN THIS VIEW

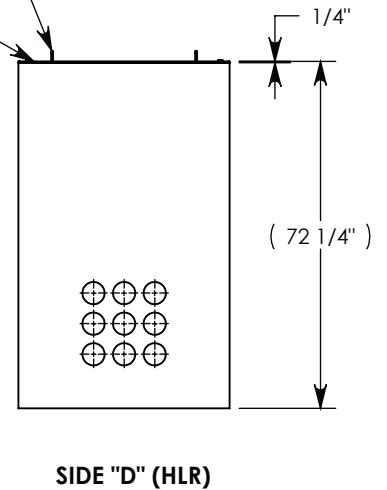
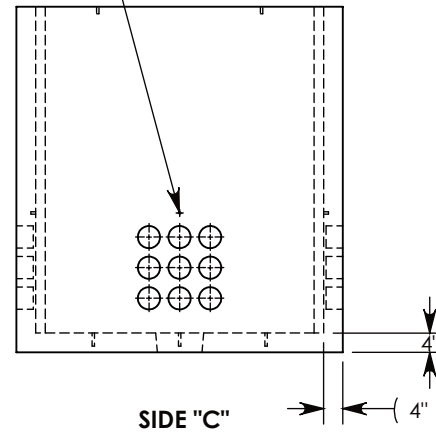
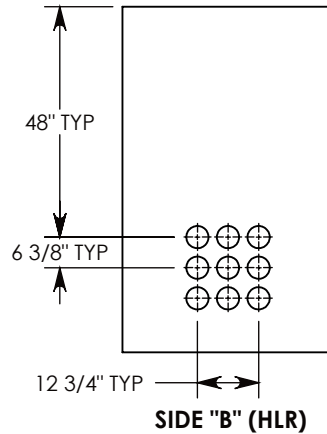
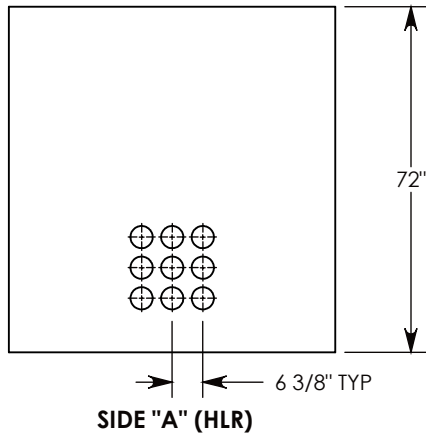

NOTE 1: FOR PVC SIZES SMALLER THAN 4", USE CONCAST RC41 (REDUCING COUPLER)  
NOTE 2: FOR ADDED SECURITY, PENTA HEAD BOLTS (P/N: PTA.5-1.5) CAN BE ADDED

PEDESTRIAN RATED - 200 LB. PER SQ. FOOT

<b>DRAWN BY:</b> MALACHI MLINAR	
<b>CREATED DATE:</b> 7/31/2018	<b>REVISION LEVEL:</b> B
<b>SAVED DATE:</b> 2/28/2020	<b>SAVED BY:</b> scallahan
<b>WEIGHT:</b> 5550 LBS.	<b>MATERIAL:</b> NOTED

1010 NORTH STAR DRIVE  
P.O. BOX 69  
ZUMBROTA, MN 55992-0069

<b>DESCRIPTION:</b> <b>PULL BOX W/ ALUMINUM COVER</b>		SHEET 1 OF 1
DIMENSIONS ARE IN INCHES TOLERANCES: FRACTIONAL: ± 1/8" ANGULAR: ± 2°	CONTACT INFORMATION: EMAIL: INFO@CONCASTINC.COM PHONE: (507) 732-4095 FAX: (507) 732-4094	
<b>PART NUMBER:</b> PB9-44-68-72-A		